



POWER LINE FIRE PREVENTION FIELD GUIDE

2008 EDITION



Power Line Fire Prevention Field Guide

November 2008

*Arnold Schwarzenegger
Governor
State of California*

*Mike Chrisman
Secretary for Resources
The Resources Agency*

*Ruben Grijalva
Director CAL FIRE*

*Kate Dargan
State Fire Marshal*

Contents

Section 1

Foreword	1-1
1. Introduction	1-2
2. Electric Power	1-3
2.1 Generation	1-3
2.2 Transmission	1-3
2.3 Distribution	1-3
3. Fire Hazard	1-5
4. Utility Pole/Tower Vegetation Clearance	1-5
5. Conductor Clearances	1-5
6. Exemptions	1-6
7. Special Concerns	1-7
8. Training	1-8
Inspection Policies	
9. Exemption Policy	1-10
9.1 Exemption Procedures	1-10
10. Inspection Policy	1-11
10.1 Utility Company Inspections	1-11
10.2 Fire Protection Agency Inspections	1-12
10.3 Joint Inspections	1-13
10.4 Ground Inspections.....	1-13
10.5 Aerial Inspections	1-14
11. Location Identification.....	1-14
12. Hazardous Tree Identification	1-20
12.1. Recognizing Potential Root Defects	1-20
13. Leaning Trees	1-20
14. Heart Rot	1-21
14.1 Recognizing Heart Rot	1-21
14.2 Degree of Hazard from Heart Rot or Butt Rot	1-21
15. Trunk Deformities	1-21
15.1 Dwarf Mistletoe Cankers.....	1-21
15.2 Man Caused Deformities.....	1-22
15.3 Forked Trees	1-22
15.4 Combination Defects.....	1-22
16. Defective Limbs	1-22
16.1 Size of Limbs	1-22
16.2 Location of Limbs	1-22
16.3 Relative Durability of Wood	1-23
16.4 Weather Conditions.....	1-23
16.5 Guidelines for Dead Limb Removal.....	1-23
17. Top Defects	1-23
17.1 Dead Tops	1-23
17.2 Broken Out Tops and Volunteer Tops	1-24
18. Other Crown Conditions.....	1-24
18.1 Thick Growth	1-24
18.2 Structure.....	1-24
19. Techniques and Aids.....	1-24
Statutes and Regulations	1-25
Section 4021.....	1-25
Section 4101.....	1-25
Section 4117.....	1-25
Section 4119.....	1-25

Section 4125.....	1-25
Section 4126.....	1-26
Section 4127.....	1-26
Section 4128.....	1-26
Section 4171.....	1-26
Section 4202.....	1-26
Section 4290.....	1-27
Section 4291.....	1-27
Section 4292.....	1-29
Section 4293.....	1-29
Section 4294.....	1-30
Section 4295.....	1-30
Section 4296.....	1-30
Section 4435.....	1-30
Government Code	1-31
51175	1-31
51177	1-31
51178	1-32
51182	1-32
51183	1-33
51189	1-33
Health and Safety Code	1-34
Section 13001.....	1-34
Section 13007.....	1-34
Section 13009.....	1-34
Section 13009.1	1-35
Section 13009.5	1-35
Title 14, California Code of Regulations.....	1-36
Section 1250.....	1-36
Section 1251.....	1-36
Section 1252.....	1-37
Section 1252.1	1-37
Section 1252.2	1-37
Section 1253.....	1-37
Section 1254.....	1-38
Section 1255.....	1-38
Section 1256.....	1-39
Section 1257.....	1-39
Section 1258.....	1-39
General Order No. 95, (Public Utilities Commission)	1-45
Code of Federal Regulations	1-45
Section 261 - Prohibitions.....	1-45
Section 261.10	1-45
Section 261.50	1-45
Section 261.52	1-46
Local Ordinances	1-46
Terms and Conditions of Permits and Easements	1-46
Section 2 – Non-Exempt	
Section 3 – Exempt	
Section 4 – Construction	
Section 5 – Bulletins/Correspondence	
Section 6 – List of Figures/Glossary of Terms	
List of Photographs and Figures	6-1
Glossary of Terms	6-5

Section 1

Foreword

This Guide contains standards, Statutes and regulations that are necessary to minimize wildland fires that may be caused by the operation and maintenance of electrical power lines and energized electrical equipment used in the delivery of electrical power. These standards are based upon the studies and experiences of fire agencies and power line operations personnel, as well as on federal regulations and the laws of the State of California. These standards, statutes and regulations are to be considered minimum guides. Field conditions may indicate the need for efforts beyond these minimums.

Except for sample copies retained for historical or reference purposes, all copies of prior editions should be withdrawn from circulation and destroyed. Moreover, regardless of the inferences that any reader may draw from any statement in this Guide, the law must be obeyed. Thus, if there is any conflict between any statement in this Guide and any applicable statute, regulation or order, the statute, regulation or order shall take precedence. Some of the applicable statutes and regulations are set forth in STATUTES AND REGULATIONS section of this Guide.

It is expected that all personnel who make condition inspections and surveys, inspections of power lines, or who prescribe hazard reduction work or other fire prevention measures will be thoroughly familiar with the contents of this Guide. They should use it, refer to it regularly and observe the principles, practices and guidance included herein.

This Guide was developed as a mutual undertaking by Cal Fire, the Pacific Gas and Electric Company, the Southern California Edison Company, San Diego Gas and Electric and the other electric utilities of California. Its purpose is to provide information and guidance to the personnel of the fire service agencies and electrical operators for minimum uniform application within the areas of their respective jurisdiction and franchise responsibilities. The Guide is not to be used as a substitute for proper training, but as a reference for personnel already familiar with the subject.

This edition of the Guide has been substantially revised not only to reflect changes in laws, regulations, policy and technology, but also to enhance its usefulness as a working field tool. This guide is not intended to dictate to electrical utilities the methods which they must use to construct their facilities. However, this guide does detail fire hazard reduction maintenance procedures for safety of their conductors and for certain items of hardware, in addition to the safety of the public.

1. Introduction

It is our intent that this edition of the Power Line Fire Prevention Field Guide will continue the partnership between fire agencies and the electric utilities. By working together and sharing expertise, technology, communications, training and data gathering, we can enter a new era of fire prevention and savings to the taxpayers and shareholders, both in dollars and in the valuable California environment.

Partnership Projects should consist of ideas and projects which further both fire prevention and economic efficiency as well as savings for the electric utilities.

Of the most vital importance is communication between the fire agencies and the electric utilities. We must take the utmost advantage of the current communication technology available to us. We need to establish an electronic mail and web based bulletin board system in which all parties can freely and formally communicate. The fire agencies need to provide immediate notification to the electric utilities when fires involve their property and equipment. The electric utilities need to notify the fire agencies when their equipment or hardware might be the cause of fires unknown to the fire agencies. Critical to the prevention of fires caused by electrical power is knowing, when, where and why they occur and building this information into a GIS database which is shared by the fire agencies and electric utilities for future models and projects.

Currently, electric utilities are making an effort to inventory and map their power lines, power poles, hardware, equipment and vegetation in a GPS and GIS system database. Performance and statistical data can be used to monitor exempt and non-exempt hardware both inside and outside the established fire hazard severity zones.

An expansive database can be used to focus and monitor vegetation management and maintenance in the fire hazard severity zones. Tree inventories can be beneficial to both the fire protection agencies and the electric utilities in both planning and maintenance situations.

Power line maintenance and construction can become a part of the Fire Protection Planning process in the construction of residential settings in the Wildland/Urban interface areas which are constantly expanding and growing.

Working together with the local electric utility representatives in training programs, inspection programs, maintenance programs, mapping projects and fire protection planning, is an investment of time and money which will ultimately save time, money and the valuable natural resources of California for future generations.

2. Electric Power

Electricity differs from other products because it is manufactured and used at the same instant. However there are similarities between it and other manufactured goods. First, a factory is required for production. For electricity this is the generating station. Second, the product must be transported in bulk to a distribution center. This is accomplished by use of high-voltage transmission lines. Third, from the distribution center, the product must be placed in the hands of the customer. Electricity makes its final journey to the customer over distribution lines.

2.1 Generation

At the present time, there are only two practical methods for manufacturing electricity in the large quantities needed to supply an area such as California. They are hydro-electric generation, which utilizes falling water as a means of turning a turbine generator, and steam generation, which requires a fuel to convert water to steam, which in turn drives a turbine generator.

The voltage at which electricity is generated varies depending on the installation. This voltage is then boosted by step-up transformers at the generating plant to the high voltage required for transmission over long distances.

2.2 Transmission

The transmission voltages in common use are 36 kV to 500 kV. It is then transmitted over tower lines to centrally located transmission and distribution substations.

2.3 Distribution

Distribution voltages commonly in use are 2.4 kV to 35 kV. Distribution circuits supply transformers which reduce the voltage so that it can be utilized by the customer. The secondary voltages which are normally supplied to the customer are 120 volts to 480 volts.

Figure 1-1 Electrical Power System

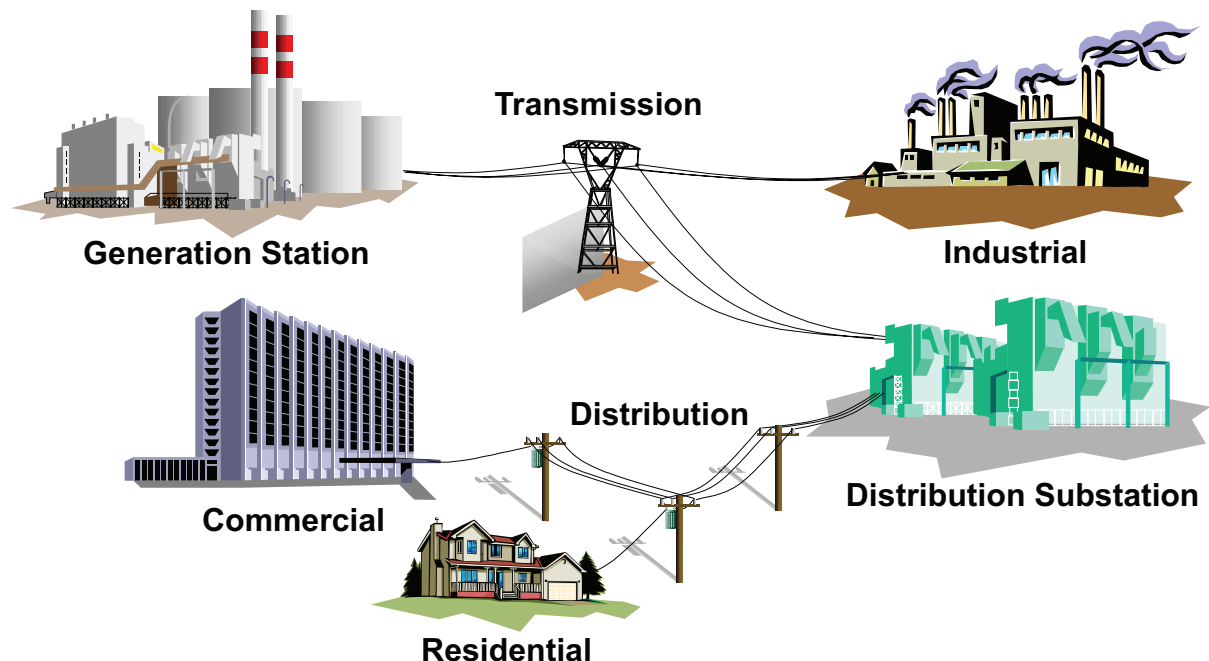
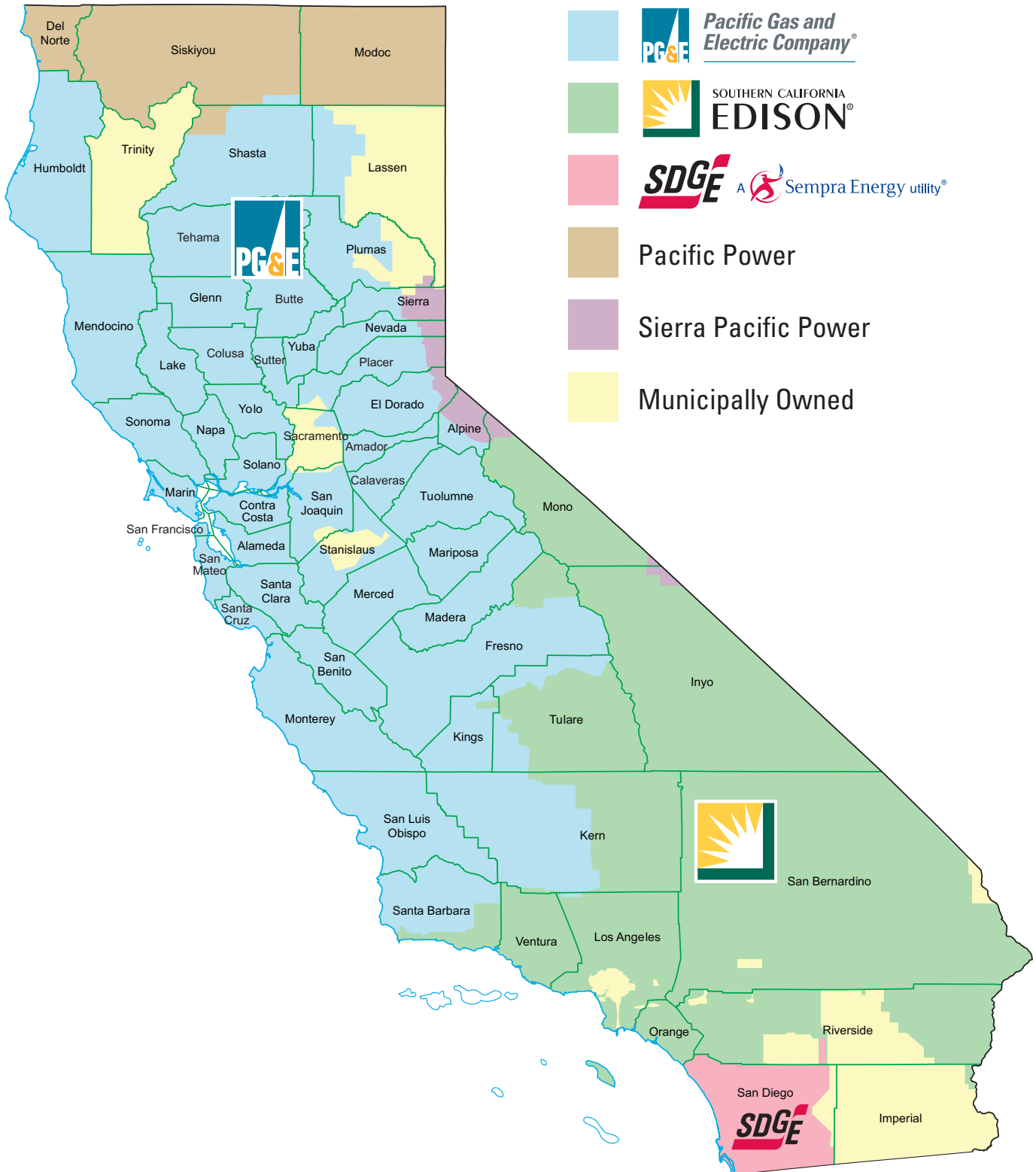

Figure 1-2 Major California Utility Companies



3. Fire Hazard

Electrical power presents an unusual hazard which brings about a mutual concern on the part of Local, State, Federal fire protection agencies and the electric utilities for making the transmission and distribution of electrical power as fire safe as possible. Fire protection agencies in their regulatory roles are concerned with public safety, loss and damage to natural resources and watershed as well as the costs of fire suppression. The electric utilities, both publicly and privately owned, are concerned with minimizing potential electrical fire hazards and minimizing interruptions of service to their customers.

This mutual concern has led to the creation of several editions of this Guide and now, to this revision. This Guide will be useful to, and used by, utility employees and the Local, State and Federal fire and resource protection agencies.

The potential exists that power line caused fires will become conflagrations during the long, hot and dry fire season commonly experienced in California. The very same weather conditions that contribute to power line faults also lead and contribute to the rapid spread of wildfire. The most critical of these weather factors is high wind, which is commonly accompanied by high temperatures and low humidity.

High, gusty winds may cause vegetation to sway into power lines, break off limbs or fall into power lines. High winds may also create vibrations in power lines that can lead to stress failures or cause loose connections to separate. Arcing usually accompanies such faults. Automatic Reclosers re-energizing the line into the fault may cause repeated arcing and increase the probability of igniting vegetation.

4. Utility Pole/Tower Vegetation Clearance

The basic requirement for clearances around poles and towers is contained in Section 4292, of the California Public Resources Code (PRC). This section requires clearing of flammable fuels for a minimum 10 foot radius from the outer circumference of certain poles and towers (non-exempt or subject poles or towers). The minimum clearance requirements are based on the type of hardware affixed to the line at the pole or tower. The distances for clearance requirements must be measured horizontally, not along the surface of sloping ground.

For the specific procedures and requirements for compliance with Section 4292 of the Public Resources Code, see the Statutes and Regulations Section of this Guide.

5. Conductor Clearances

The basic requirements for clearances around electrical conductors are set forth in Section 4293, of the California Public Resources Code (PRC). This section requires clearance of all vegetation for a specific radial distance from conductors, based on the voltage carried by the conductors: four feet for voltages between 2,400 volts and 72,000 volts; six feet between 72,000 volts and 110,000 volts; and ten feet over 110,000 volts.

In addition this section requires the removal or trimming of trees, or portions of trees, that are dead, decadent, rotten, decayed or diseased and which may fall into or onto the line and trees leaning toward the line.

Some company policies require considerably more clearance as a general rule or in special situations, such as unusually long spans in high wind areas. This is especially true where the line is passing through an area of rapidly growing vegetation.

In many cases, the utility right-of-way or easement is considered the primary fire break by the fire agencies. The stacking or accumulation of debris resulting from tree trimming or removal operations should be avoided on these fire breaks. When these conditions exist, the debris should be chipped and scattered, avoiding the possibility of compromising the fire break.

6. Exemptions

Exemptions to the conductor clearance requirements are contained in Sections 4292, 4294, 4295 and 4296, PRC. Section 4293 authorizes other exemptions by administrative regulation. Exemptions are found in Title 14, Section 1257, California Code of Regulations.

The first exemption is in PRC Section 4292, which states that any line used exclusively as a communications circuit and so classed by the Public Utilities Commission, is exempt from the pole or tower clearance requirement. Railroad circuits, for instance, are used primarily for communication purposes but also provide power, more than 750 volts to operate track switches, and thus are not exempt.

Section 4292, PRC also authorizes the Director of Cal Fire, and certain others, to make exceptions. Exceptions are contained in Title 14, Section 1255, Code of Regulations (CCR). These exceptions concern installed hardware and ground cover.

Section 4295 PRC recognizes private property rights by not requiring trespass if that is the only way in which clearance requirements can be maintained. It is not, however, intended as a loophole. Utilities are expected to make reasonable effort to secure permission to make the clearances and, if unsuccessful, to report their problem to the responsible fire protection agency. The agency can then attempt to persuade the property owner to allow the clearing.

Section 4296, PRC exempts lines carrying voltages of 750 volts or less. It has been found, however, that such lines, which are not insulated, can start fires. It is therefore considered good practice to maintain some clearance on these lines.

Title 14, Section 1255, exempts poles or towers where the conductors are continuous, or if not continuous, where they are joined by automatic, compression, copper or aluminum parallel groove connectors (i.e. Figures 3-73, 3-63 and 3-46). Automatic connectors are non-exempt if installed on jumper or other slack wires since they will not hold except under tension. Hot line tap or clamp connectors are exempt only if they are designed to absorb any expansion or contraction by applying spring tension on conductors (Figure 3-50). This section also exempts completely sealed and liquid filled equipment (Figures 3-1 through 3-19). Plate connectors are exempt, provided they are held together by two or more bolts (Figure 3-66). Solid blade, single-phase bypass switches and solid blade, single phase disconnect switches associated with circuit reclosers, sectionalizers and line regulators and Fargo FA 300 series piercing connectors when used with tree wire, are exempt. (Figures 3-36, 3-38, 3-40, 3-53).

The exemptions in Title 14, Section 1255, are related to the vegetation growing around the pole or tower. The subsections relate to essentially nonflammable vegetation that will not spread fire. Subsection "c" covers vegetation maintained for the specific purpose of soil erosion and fire prevention. This is not intended as a loophole. The key words are "specific purpose", and they require a positive demonstration of this purpose in order to qualify.

7. Special Concerns

Legal considerations aside, special circumstances can exist that require additional hazard reduction measures in order to prevent fires or the liability that might arise from them.

Large birds and raptors are a fairly common hazard causing the need for special measures, as they frequently develop a liking for a particular pole or tower as a roosting place. Two fire prevention problems arise from this situation. First, their droppings build up on insulators to the extent that the potential exists for a flash-over between conductors and the crossarm. This situation can cause a line fault and the potential for glowing debris to fall from the pole to the ground. Secondly, during take-off or landing, their wings can touch two conductors simultaneously and create a short circuit. This situation can cause the bird to fall to the ground and ignite dry vegetation below the conductor. When such poles or towers are discovered, the ground should be cleared of all vegetation around them as a fire prevention measure. During inspections, an LE-38, LE-38A, USFS 5100-209 or LE-100 should be written, as advisory only, should these conditions be found. These situations may also be remedied with the installation of raptor construction (Figures 4-15 through 4-24).

Similar problems have been found and exist involving small birds and climbing animals resting on transformers. Some utilities use a plastic wildlife protection boot over one bushing of the transformer to prevent birds and animals from causing a direct short-circuit between the transformer bushings. Again, an advisory LE-38 should be written when these conditions are found.

Other conditions that may lead to potential fire problems are damaged hardware, damaged insulators, weather or bird damaged poles and broken strands on conductors. Porcelain insulators will allow a flash over if they lose too much of the skirt. Broken crossarms, damaged poles or bent brackets and braces can allow conductors to touch the ground or come into contact with each other. These situations, if not corrected, allow a potential wildfire to exist.

Not only do the aforementioned situations create potential fires, they lead to other problems which the utilities are anxious to repair as soon as possible. If you find any of these situations to exist, immediately notify the utility company having jurisdiction, that the conditions exist and the exact location of those conditions.

Vegetation should not be cleared from right-of-ways, except as necessary to effect required clearance around poles and towers, as the vegetation holds soil in place and presents a natural environmental appearance.

Situations exist in which the minimum legal clearance is clearly inadequate, such as localized high or turbulent winds found in canyons or extremely high local air temperatures in low elevation canyons.

Hazardous conditions may also occur from natural or man-made causes. Snags left from old burns or insect kills sharply increase the potential for dead or dying trees to fall into power lines. In these instances it may be necessary to fall or trim trees beyond the legally required distance from conductors.

Standard unprotected conductors, for primary distribution lines, and self-supporting aerial cable, can only be attached to trees in accordance with Title 14, Section 1257. However, in no case are conductors of any kind to be mounted to snags or dead trees.

8. Training

This Guide is to be used as a reference for personnel already familiar with the subject areas contained within.

This Guide is also to be used as the base level of knowledge necessary to perform adequate, accurate, and complete inspections which require that personnel using this guide be properly trained as to the application of the contents of this guide.

Training is available through the CAL FIRE Fire Academy, Region Office Fire Prevention Section or the CAL FIRE Unit Fire Prevention Bureau.

Inspection Policies

Basic Laws Pertaining to Power Line Operations Quick Reference Table

Public Resources Code

PRC Section 4292: 10 Foot Fire Break Required.....1-29
PRC Section 4293: Conductor Clearance Required1-29

4 Feet 2.4 - 72 kV

6 Feet 72 - 110 kV

10 Feet Over 110 kV

PRC Section 4294: Aerial Cable Exempt from Conductor Clearance1-30
PRC Section 4295: Trespass Not Required1-30
PRC Section 4296: Lines with 750 Volts or Less are Exempt1-30

California Code of Regulations Title 14, Article 4

Section 1250: Purpose1-36
Section 1251: Definitions1-36
Section 1252: Areas where PRC 4292 - PRC 4296.5 in State Responsibility Areas1-37
Section 1253: Time when PRC 4292 - PRC 4296 Apply1-37
Section 1254: Minimum Clearances - PRC 42921-38
Section 1255: Exemptions to Minimum Clearance Provisions of PRC 42921-38
Section 1256: Minimum Clearance Provisions of PRC 42931-39

9. Exemption Policy

Policy for Qualifying Electrical Equipment and Devices for Exemption from Public Resources Code Section 4292.

The utility will submit all exemption requests to Cal Fire Prevention Engineering Section at Sacramento Headquarters and will include at least the following:

- Photograph's and description of equipment/devices tested (photo size 8 x 10 minimum)
- Description of testing procedures, i.e. ANSI Standard C37.40 - 1981
- Test results
- Professional Electrical Engineers conclusions

Written notification will be forwarded to the utility within 60 days after receipt of the request for exemption by Cal Fire. Notification will consist of at least the following:

- Approval or denial of exemption
- Justification for the determination

9.1 Exemption Procedures:

Equipment and devices will be tested to ensure compliance according to the test procedures outlined in this standard prior to obtaining an exemption from Public Resources Code Section 4292 from Cal Fire.

- CDF Fire Prevention Engineering Section will be notified 30 days prior to an exemption test.
- The electrical tests, for determining compliance, will be conducted under the direction of an Electrical Engineer using test equipment capable of making and breaking preset loads. The current, voltage and starting and ending times shall be graphically recorded and become a permanent part of the documentation of the request for exemption.
- Tests will be conducted utilizing a fuel bed representative of flammable vegetation (dead, dried grass or equivalent), with a fine fuel moisture of 5% at 70° - 89° degrees Fahrenheit and an accompanying wind speed of 10 MPH or more.
- All equipment installed on lines shall be operated within the maximum manufacturers duty rating of the equipment or device.
- Equipment will be installed under actual field conditions according to manufacturers specifications while undergoing testing.
- Enclosed devices, i.e., reclosers, sectionalizers, autotransformers, non-expulsion devices etc., shall be designed so no external arcs/sparks or expelled hot particles will be generated during the operation.
- Open type or fixed devices, i.e., air switches, open link fuses, connectors, lightning arresters, manual by-pass switches and disconnects shall interrupt line current and short circuit current within the design range without creating arcs/sparks or hot particles that would ignite flammable vegetation.
- The equipment or overhead device, when installed according to the manufacturers' recommendations, must be fire safe, by test, where exposed/anticipated electrical arcs or hot material could be generated.
- Overhead line equipment and devices that may generate exposed electrical arcs, sparks or hot material during their operation shall be designed to limit any such arcs, sparks or hot materials sufficiently to prevent the ignition of flammable vegetation.
- Igniting any portion of the test bed will disqualify the device when testing is conducted in the above described environment.

10. Inspection Policy

Both utilities and fire protection agencies have responsibilities for inspection of power lines. However, the reasons and purposes of their inspections are different. Although joint inspections are desirable and helpful, often they are not practical.

The utilities have an operational and management responsibility for inspecting their lines. They must determine what work needs to be done in order to comply with laws and use permits, and to prevent fires and avoid interruption of customer service. They also need to know, after the work is assigned, whether or not it has been done and to what standards.

The fire and resource protection agencies' inspection responsibilities are primarily regulatory. They should make inspections (spot checks) of as small or large an area as necessary (seldom a complete inspection of an entire circuit) to satisfy themselves that the electric utility complies with, statutes, regulations, and use permits. These inspections should normally be done in late spring or early summer. The protection agency should notify the utility in writing of its findings.

Correction of violations and maintenance of required clearances and other safety measures are the responsibility of the utilities. Much of the clearance work is done by contractors. Neither contractors nor utility company employees should pass by an obvious violation or other problem because it is not on their assigned work list. Also, fire protection agency personnel should never ignore an observed violation or piece of broken or damaged equipment. It should be reported to the utility, in writing as soon as possible, so that the defect may be promptly corrected.

Cal Fire, USDA Forest Service, US Bureau of Land Management, and other wildland protection agencies may initiate criminal actions to secure compliance with laws and ordinances. These agencies also may process civil actions for collection of fire suppression costs and damage to their resources. Protection agencies will not take indiscriminate actions. However, when violations are present and can be supported by facts, a citation or criminal complaint may be issued.

10.1 Utility Company Inspections

The responsibility for inspection of power lines for compliance with statutes, regulations, and use permits, rests exclusively with the utilities.

The most basic method of power line inspection is visual, conducted by ground or air. This method of inspection can determine accurately whether required clearances exist, structures are in need of repair, etc.

An infrared (IR) scan is used to detect components with thermal anomalies. Improper or loose connections, as well as most other incipient deterioration, create electrical resistance and, therefore, heat. Heat often cannot be detected visually but shows up clearly during an IR scan.

In terms of exposure, there are 5 to 10 times as many miles of distribution lines as transmission lines. Fire protection agency statistics show that more fires start from distribution lines than from transmission lines. Distribution circuits commonly carry more non-exempt hardware (clearance required) and are built with less conductor clearance than are transmission lines. Therefore, distribution lines should also receive frequent inspection.

The frequency of inspection of both transmission and distribution lines depends on various other factors but are not limited to: type and growth rate of vegetation, accessibility to fire fighting forces, frequency of strong or gusty winds and fire history. Inspection schedules must be flexible enough to accomplish their purpose.

10.2 Fire Protection Agency Inspections

The fire protection agencies are charged with the responsibility of protecting the public from loss of life, property and natural resources by fire. Fire Protection Agencies are also charged with enforcing the forest and fire laws, statutes, regulations and use permits. To accomplish these missions, they inspect power lines to prevent wildfires. Protection agency inspections do not, however, relieve public utilities of the responsibility of inspecting their own facilities. Public fire protection agencies do have a duty to make known to utilities those violations and defects noted during their inspections. Protection agency personnel will seldom make a complete inspection of an entire circuit. Their procedures include: spot inspections of individual poles, towers, spans, or short segments of circuits; general surveys (usually by air); compliance checks following prior notification of violations; detailed inspections of small areas (because of fire or complaint).

Most fire agency inspections are adequately conducted by visual inspection. Inspectors should be equipped with such aids as binoculars, magnifying glasses and cameras. The use of such equipment is particularly important when making fire-cause investigations, but can also be quite helpful in conducting inspections. Because of the danger of electrocution, fire agency personnel are NOT to attempt to physically or mechanically measure conductor clearances. Visual estimation is adequate.

The result of any fire agency inspection should be properly recorded. Each agency has its own forms and procedures for this purpose. Fire-cause investigations will usually be recorded on

special forms. Other types of useful forms which are used by the CDF, USFS and BLM in California, are the California Fire Safety Inspection Report LE-38 or USFS 5100-209, LE-38A or LE-100 (Figure 1-3, page 1-15) (Figure 1-4, Page 1-16) and Figure 1-5, page 1-18. Regardless of the format of the report, a copy should be sent or given to the electric utility. Reports should be specific enough for the utility to act on their findings and for the courts to relate them to complaints or other legal actions in the event such actions are filed.

If fire protection agency personnel notice conditions on power lines that are not violations of fire laws or regulations but which may cause an electric fault, a hazard to linemen, a break in customer service, etc. When noticed, such items should be noted on the inspection report and/or reported to the utility immediately. Verbal notice is usually adequate but must be followed up with a written notice to ensure that the condition is resolved and compliance is achieved. Should a wildfire occur as a result of a fault, hazard or violation, etc., proper recording is necessary to establish liability and criminal negligence.

A planned program of inspections to gain compliance with fire prevention laws, aimed at reducing wildfire occurrence, will be carried out by the Fire Protection Agencies. The program must be as long range and flexible as needs require.

As hazard and risk problems change, the emphasis of any fire prevention program must also change to meet the problem.

Success depends on the fire prevention inspector and the inspection program. The inspector's aim must be to handle all contacts in such a way that people will be favorably impressed and will have confidence in the Fire Protection Agencies.

The authority for the Cal Fire, USFS, and BLM to enforce California forest and fire laws is Public Resources Code, Section 4119 that authorizes the Department or authorized agents to inspect all properties, except a dwelling's interior, to ascertain compliance with state forest and fire laws, regulations or use permits.

To perform the inspection successfully, the inspector should have specific tools:

- A. Badge, name plate and shoulder patch.
- B. Agency identification card.
- C. The California Interagency Fire Safety Inspection Form and a notebook to record the inspection and to take notes of hazards and risks. Sketched maps aid in future inspections or fire fighting operations.
- D. Copies of laws, regulations, ordinances, use permits and fire prevention material.
- E. Prior inspection records.
- F. Binoculars, camera and circuit maps if available.

After completing the inspection, the inspector should note all violations in writing on the Interagency Inspection Form and set a definite time limit for compliance. The time limit should be reasonable for the amount of work to be done. The inspector may consult the electric utility and jointly set the time limit, if within reason, since the work will more likely be completed on time.

The more critical the situation, the more urgent compliance becomes. However, weather conditions, stage of the vegetation cure and approaching windy seasons should dictate allowable time for the work's completion.

Follow-up inspection is absolutely necessary for effective inspections. The electric utility should understand that the inspector will be re-inspecting the violation immediately after the date set for compliance. If the inspector does not go back, the value of the inspection will be lost and a potential fire may still continue to exist.

10.3 Joint Inspections

Joint inspections are for the purpose of educating both fire protection agencies and electric utility personnel with possible violations and other power line problems. Joint inspections are not always possible because of time commitments or agency policy. They are, however, encouraged to the extent feasible, as they provide an excellent opportunity for mutual training, understanding and trust.

Usually the most productive form of joint inspection is the quick general survey of a complete circuit from either a motor vehicle or aircraft. Joint inspections should be documented.

10.4 Ground Inspections

Ground inspections may be made either in a motor vehicle or on foot. In either case, they are most efficiently performed by two-person teams. When inspecting from a vehicle, one team member should devote his entire attention to driving while the other observes the power line. The speed of the vehicle should be that needed for good observation.

Power lines often do not follow roads, or even off-road routes. Therefore, inspection must sometimes be done on foot. These segments often contain the greatest number of violations. In order to avoid wasting time, one person should walk the line while the other drives to a point where the line again crosses a road. If the line crosses the road and again goes cross-country, the team members can switch roles.

10.5 Aerial Inspections

Aerial inspection is an excellent means of covering a lot of territory quickly and at minimum cost. Some of the larger utilities own and operate their own aircraft. There are several contractors who fly regularly for both power and telephone utilities. Most protection agencies have aircraft available. Several cost studies have shown that aerial inspection is less expensive than ground inspection in off-road situations that would otherwise require walking.

Helicopters may be used for power line inspections. Their maneuverability and ability to fly slowly and to hover makes them ideal for this purpose. Cost per flight hour is, however, from two to eight times that of an appropriate fixed-wing aircraft, and cost must be weighed in respect to the thoroughness of inspection needed. It has been demonstrated that with proper planning, preparation, training (of both pilot and observer) and experience, an adequate job of power line inspection can be accomplished from the air using either helicopters or fixed-wing aircraft. Results of aerial inspections should be ground checked until both pilot and observer have accumulated experience.

Aerial inspection is particularly good for spotting pole or tower clearances, leaning or dead trees not immediately adjacent to the line and the larger pieces of hardware requiring pole or tower clearance. It is also an excellent means of making infra-red inspections. A skilled observer can do many phases of power line inspection equally well from the air as from the ground. However, it is rather difficult to identify small items of hardware, conductor clearances or the less obvious tree defects accurately from the air.

11. Location Identification

Wildland fire protection agencies and electric utilities have two different systems of position or location identification. In order for communications (including inspection reports, inquiries regarding problems, etc.) to be meaningful, it is essential that both groups of people have at least a working knowledge of the other's system. There is not space here to completely define either system. Local joint training sessions should be utilized to acquaint personnel with these systems.

Most wildland fire protection agencies use the so called "GLO" (General Land Office) system of position location. This system defines locations by means of section, township and range. More detailed locations will be given by quarter section. This grid system is relatively easy to learn, but not always easy to apply accurately on the ground. The grid is usually superimposed on fire agency administrative maps, USGS topographic maps, and other maps. It is seldom shown on utility maps because it is not sufficiently precise to identify the location of an individual pole, tower, or conductor span.

The electric utilities, with some variation between systems, generally identify locations by circuit name, number and pole, tower or hardware number. Transmission lines usually are named and each pole or tower is numbered. One common system of such numbering is a fraction, the top number being the mile from the point of beginning and the bottom number being the number of the pole or tower within that mile. Other numbering systems are in use and the system used by a particular utility must be learned by fire agency personnel. Depending on the utility, distribution circuits may be numbered, named or both. Some utilities also number individual poles as well as just identify Subject Poles. Also, items of major equipment (e.g. automatic reclosers, switches, disconnects, etc.) are numbered. Poles without pole or equipment numbers must be located by reference to existing pole or equipment numbers (e.g. "fourth pole north of disconnect 6859", or "second pole west of pole 1892096E"). (See Figure 1-6 and 1-7, Page 1-19)

Figure 1-3

CALIFORNIA INTERAGENCY FIRE SAFETY INSPECTION LEGAL NOTICE

591651

INSPECTOR'S NAME: TITLE:

DATE OF INSPECTION: MONTH DAY YEAR

OTHERS PRESENT:

MAY BE CONTACTED AT: ()

INSPECTEE'S NAME: ADDRESS:

LOCATION OF INSPECTION:

FOLD LINE NO VIOLATION OBSERVED AT THIS TIME. INSPECTION STICKER ATTACHED. YOU ARE HEREBY NOTIFIED TO CORRECT THE VIOLATIONS SPECIFIED BELOW. BEFORE OPERATING EQUIPMENT LISTED. VIOLATION TAG ATTACHED. REINSPECTION WILL BE MADE ON OR AFTER MONTH DAY YEAR FOLD LINE

SEE "EXCERPTS FROM STATE AND FEDERAL LAWS" BELOW. NOTE SECTIONS CHECKED. FOLD LINE EXCERPTS FROM STATE AND FEDERAL LAWS FOLD LINE

(PRC) Public Resources Code (HASC) Health & Safety Code (CAC) California Administrative Code STATE LAW LEGAL AUTHORITY Certain Forest Service Officers are authorized to enforce State Fire Laws. They are: 1. Those who hold Voluntary Fire Warden and Peace Officer's appointments from the California Department of Forestry. 2. Other Forest Service employees designated pursuant to the Joint Forest Service/California Department of Forestry Fire Cooperative Agreement. PERMITS FOR BURNING A person shall not burn any brush, stumps, logs, fallen timber, fallows, slash, grass, brush, forest, or other flammable material in any area receiving fire protection by the department or upon federal lands administered by the United States Department of Agriculture or Department of the Interior, unless he has a written permit from the department or its duly authorized representative or the authorized federal officer on federal lands administered by the United States Department of Agriculture or Interior and in strict accordance with the terms of the permit. (PRC 4423) CAMPFIRES A person shall not light, maintain, or use a campfire upon any brush, grass, or forest covered land which is the property of another person unless he first obtains a written permit from the owner, lessee, or agent of the owner or lessee of the property. If conditions have been established and passed for camping, a permit is not necessary. (PRC 4433) USFS FORM 100-5100-209 (REV. 12/89) CDF FORM LE-38 (REV. 12/89)

FIRE HAZARD REDUCTION AND EQUIPMENT CLEARANCES AROUND STRUCTURES Any person that erects, leases, controls, operates, or maintains any building or structure in, upon, or adjoining any meadowland or forest, brush, or grass covered lands, or any land covered with flammable material, shall do all the following: (a) Maintain around and adjacent to building or structure a fuelbreak for a distance of not less than 30 feet on each side or to the property line, whichever is greater. This does not apply to simple trees, ornamental shrubbery, or similar plants which are used as ground cover, if they do not form a means of rapidly transmitting fire from the native growth to any building or structure. (b) Maintain around and adjacent to any building or structure adequate fire protection or fuelbreak which is located from 30 feet to 100 feet from each building or structure or to the property line, whichever is nearer, as may be required by the Director, because of extra hazardous conditions. Grass and other vegetation located more than 30 feet from such building or structure and less than 18 inches in height above the ground may be maintained where necessary to stabilize the soil and prevent erosion. (c) Remove that portion of any tree which extends within 10 feet of the point of any chimney or stovepipe. (d) Maintain any tree adjacent to or overhanging any building free of dead or dying wood. (e) Maintain the roof of any structure free of leaves, needles, or other dead vegetation growth. (f) Provide and maintain at all times a screen near the outlet of every

chimney or stovepipe. The screen shall be constructed of nonflammable material with openings of not more than one-half inch in size. (PRC 4281) MISCELLANEOUS Every person shall exercise reasonable care in the disposal of flammable material so that the material does not cause uncontrolled fire & person shall not burn any flammable material in any incinerator within any area receiving fire protection by the Director or upon federal lands administered by the United States Department of Agriculture or Department of the Interior, unless the following minimum requirements are complied with: (a) The area within 10 feet of the incinerator is maintained clear of all flammable material and vegetation. (b) A screen constructed of a nonflammable material, with no greater than 1/4 inch mesh, or metal doors, cover each opening in the exterior to prevent the escape of burning material. (c) A permit is obtained prior to burning. (PRC 4446) EQUIPMENT During any time of the year when burning permits are required in an area, no person shall use or operate any motor, engine boiler, stationary equipment, welding equipment, cutting torch, tar pot, or grinding device which is located on or near any forest, brush, or grass covered land, without doing both of the following: (a) Clearing away all flammable material, including stumps, around such operation for 50 feet. (b) Maintain one accessible round point shovel and one backpack jump water type fire extinguisher ready for use at the immediate area during the operation.

INSPECTEE COPY

(CONTINUED ON REVERSE SIDE) 7540-130-0038

FS 5100-209 and CDF LE-38

Figure 1-4

INTERAGENCY FIRE HAZARD INSPECTION NOTICE 012648

Inspector's Name:		Inspection Date: / /		Ranger Unit ID	Batt. No.
Inspector's Phone #:					

Inspector's Title:
 FC FAE FOR AIDE FOR 2 FPA
 BC FF-1 FOR TECH FPS 1 Other
 VIP FF-2 FOR 1 FPS 2

Inspection No: One Two Three

Assessor Parcel: Book Page Parcel

Inspectee:

Name:

Street No. Dir. Street Name

City State Zip Code Special Address:

Phone Number Latitude Longitude

Location of Inspection:

Street No. Dir. Street Name

City **Reinspection Date:** / /

Comments:

Comments:

Number Inspected (enter no.):

<input type="text"/> Structures	<input type="text"/> Camp Fire	<input type="text"/> Fire Tools
<input type="text"/> Mechanical Equipment	<input type="text"/> Open Burning	<input type="text"/> Miles
<input type="text"/> Power Line Poles	<input type="text"/> Incinerator	<input type="text"/> Other
<input type="text"/> Waste Disp. Storage		

Inspected For and Number of Violations (see back):

Violation Code (ex. H&S, CFR)	Section (ex. 4291)	Sub-Section (ex. A, C)	No. of Violations

Legal Action: Y Admin None BIA NF
 N Citation Other BLM Other
 Compl't Notice M.RES Private

Land Owner:

Special Use Permit: Y N

Protection Responsibility: SRA LRA FRA

BIA	<input type="checkbox"/>	<input type="checkbox"/>	<input type="checkbox"/>	Violation Reinspection	<input type="checkbox"/> Y
BLM	<input type="checkbox"/>	<input type="checkbox"/>	<input type="checkbox"/>	Address Visible	<input type="checkbox"/> N
CDF	<input type="checkbox"/>	<input type="checkbox"/>	<input type="checkbox"/>	Fire Resistive Roof	<input type="checkbox"/> Y
Contract County	<input type="checkbox"/>	<input type="checkbox"/>	<input type="checkbox"/>		<input type="checkbox"/> N
USFS	<input type="checkbox"/>	<input type="checkbox"/>	<input type="checkbox"/>		<input type="checkbox"/> Y
Other	<input type="checkbox"/>	<input type="checkbox"/>	<input type="checkbox"/>		<input type="checkbox"/> N

Type of Hazard:

Agriculture CampGround Comm. Wood Construction
Dwelling Mill Mineral Mtn. Cabin Org. Camp Power Line
Railroad Resort Road Sales/Ops.Area Waste Disposal Other

Type of Vegetation: Grass Brush Oak/Woodland Conifer

Water Storage

Form LE-38A (1/00)

THIS IS A LEGAL NOTICE OF FIRE HAZARD VIOLATIONS (IF NOTED ABOVE)

Figure 1-5 (front)

STATE OF CALIFORNIA
DEPARTMENT OF FORESTRY AND FIRE PROTECTION
NOTICE OF DEFENSIBLE SPACE INSPECTION
LE-100 (NEW – 5/2006)



NOTICE OF DEFENSIBLE SPACE INSPECTION INSTRUCTIONS

LE-100 Instructions (April 14, 2006 – draft – subject to change)

1. Self explanatory
2. Working job title, (FFI, Engineer, Captain, etc)
3. Self explanatory. If no badge #, enter N/A
4. Enter Abbreviations; (e.g. CAL FIRE, USFS, BLM, etc.)
5. Self explanatory
6. Check applicable box. If unknown, leave blank
7. Use three letter identifier; (e.g. RRU, LMU, etc.)
8. Optional, follow Unit policy. Use local identifiers
9. Optional, follow Unit policy. Use local identifiers
10. Optional, follow Unit policy. Use county assessor syntax
11. Optional, follow Unit policy. Use county assessor syntax
12. Optional, follow Unit policy. Use county assessor syntax
13. Optional, follow Unit policy. Set GPS to WGS84 for all readings and use Decimal Degree format as shown
14. Same as 13
15. Self explanatory
16. Self explanatory
17. Self explanatory
18. Self explanatory
19. Self explanatory
20. Self explanatory
21. Optional, follow Unit policy. Homeowner's home phone
22. Optional, follow Unit policy. Homeowner's cell phone
23. Optional, follow Unit policy. This may be useful for follow up information education campaigns
24. Comments are encouraged. Comments may include but not be limited to:
 - a. Record mailing addresses if block 15 is checked;
 - b. Suggestions or recommendations to homeowner such as moving woodpiles
 - c. explaining areas of non-compliance
 - d. explaining alternative practices you've approved under authority of 14CCR 1299b (see box 30).
25. If this is the first inspection of the calendar year, check NO. If this is a second or subsequent inspection for the calendar year, and you returning to re-inspect a previously noted violation, check YES.
26. Self explanatory
27. This only applies if a law enforcement citation or "Notice to Appear" is issued concurrent with this inspection.
28. Record the earliest date the landowner can expect a follow up inspection
29. Check this box only if there were no PRC 4291/14CCR 1299 violations noted
30. Check this box if you have approved alternative practices as allowed in 14CCR 1299b. Explain in comments section.
31. Check all that apply.
32. The first check box in block 32 is checked if the property is NOT in compliance.
 - a. This first box cannot be checked if block 29 is checked.
 - b. If this first box is checked, then there MUST be at least one box below checked.
 - c. Explanations of the remaining boxes:
 - i. "30 foot zone": If there are violations in the first 30 feet from the structure, check this box. For the grass, brush, trees, and shrubs boxes, check all that apply.
 - ii. "Reduced Fuel Zone": If there are violations in the first 30 feet from the structure, check this box. For the grass, brush, trees, and shrubs boxes, check all that apply.
 - iii. "Dead and dying woody surface fuels": This box refers to the Board of Forestry and Fire Protection's "Guidelines" document, Guideline #2.
 - iv. "Remove portion of any tree.....": this refers to PRC 4291(c).
 - v. "Maintain any tree adjacent to": this refers to PRC 4291(d)
 - vi. "Maintain the roof of a structure": this refers to PRC 4291(e)
 - vii. "Provide and maintain at all times a screen": this refers to PRC 4291(f)
33. Optional, follow Unit policy. Check all that apply.

Figure 1-5 (back)

STATE OF CALIFORNIA
 DEPARTMENT OF FORESTRY AND FIRE PROTECTION
NOTICE OF DEFENSIBLE SPACE INSPECTION
 LE-100 (NEW – 5/2006)



NOTICE OF DEFENSIBLE SPACE INSPECTION
THIS IS A LEGAL NOTICE OF FIRE HAZARD VIOLATIONS (IF NOTED IN BLOCK 32)
 SHADED BOXES **MANDATORY** - ALL OTHERS OPTIONAL

1. INSPECTOR'S FULL NAME (FIRST, M.I., LAST)		2. INSPECTOR'S TITLE		3. BADGE NUMBER		4. INSPECTOR'S AGENCY		5. INSPECTION DATE (MM/DD/YYYY)		
6. PROTECTION RESPONSIBILITY			7. UNIT ID		8. BATTALION NUMBER		9. STATION NUMBER			
SRA LRA FRA <input type="checkbox"/> <input type="checkbox"/> <input type="checkbox"/> <input type="checkbox"/> <input type="checkbox"/> <input type="checkbox"/> <input type="checkbox"/> <input type="checkbox"/> <input type="checkbox"/> Contract County <input type="checkbox"/> <input type="checkbox"/> <input type="checkbox"/> USFS <input type="checkbox"/> <input type="checkbox"/> <input type="checkbox"/> Other <input type="checkbox"/> <input type="checkbox"/> <input type="checkbox"/>			10. AP BOOK		11. AP PAGE		12. AP PARCEL #			
13. LATITUDE (Datum = WGS84) (Decimal Degrees; ex: 38.5761)					14. LONGITUDE (Datum = WGS84) (Decimal Degrees; ex: 121.4969)					
15. If mailing address for notices is other than inspection location, check here: <input type="checkbox"/> and write complete address in comments section.										
INSPECTEE	16. NAME (LAST, FIRST)									
	17. ADDRESS									
	18. CITY						19. STATE CA		20. ZIP	
	21. PHONE NUMBER #1			22. PHONE NUMBER #2			23. E-MAIL ADDRESS			
24. COMMENTS:										
<p>IF YOU HAVE QUESTIONS CONCERNING THIS INSPECTION NOTICE, CALL THIS PHONE NUMBER:</p>										
25. VIOLATION REINSPECTION? <input type="checkbox"/> YES <input type="checkbox"/> NO			26. INSPECTION # <input type="checkbox"/> 1 <input type="checkbox"/> 2 <input type="checkbox"/> 3		27. CITATION # <input type="checkbox"/> 1 <input type="checkbox"/> 2 <input type="checkbox"/> 3		28. FOLLOW-UP INSPECTION DATE: (MM/DD/YYYY) <input type="checkbox"/> N/A			
29. <input type="checkbox"/> No violations observed. (check if applicable)			30. <input type="checkbox"/> Alternative practices approved having same practical effect. See comments section above (14 CCR 1299 (c)) (check if applicable)				31. ACTIONS TAKEN <input type="checkbox"/> Left information material <input type="checkbox"/> Discussed clearance with resident <input type="checkbox"/> Left copy of this inspection notice <input type="checkbox"/> Citation issued <input type="checkbox"/> Recommend citation to prevention			
32. <input type="checkbox"/> Violations were observed. Additional clearance is needed for the following areas: (check applicable sections) <input type="checkbox"/> 30 foot zone, PRC 4291(a); 14CCR 1299(a)(1) <input type="checkbox"/> Grass <input type="checkbox"/> Brush <input type="checkbox"/> Trees <input type="checkbox"/> Shrubs <input type="checkbox"/> Reduced Fuel Zone (30' – 100') PRC 4291(b); 14CCR1299 (a)(2) <input type="checkbox"/> Grass <input type="checkbox"/> Brush <input type="checkbox"/> Trees <input type="checkbox"/> Shrubs <input type="checkbox"/> Remove specific hazardous fuel identified by inspector - 14CCR 1299(b) <input type="checkbox"/> Dead and dying woody surface fuels - 14CCR1299(d) <input type="checkbox"/> Remove portion of any tree that extends within 10 feet of the outlet of a chimney or stovepipe PRC 4291(c) <input type="checkbox"/> Maintain any tree adjacent to or overhanging a building free of dead or dying wood - PRC 4291(d) <input type="checkbox"/> Maintain the roof of a structure free of leaves, needles, other dead vegetation - PRC 4291(e) <input type="checkbox"/> Provide and maintain at all times a screen over the outlet of every chimney or stovepipe that is attached to a fireplace, stove, or other device that burns any solid or liquid fuel. The screen shall be constructed of nonflammable material with openings of not more than one-half inch in size. PRC 4291(f)						33. GENERAL BUILDING CONSTRUCTION TYPE <input type="checkbox"/> Wood Siding <input type="checkbox"/> Wood Roof <input type="checkbox"/> Non-combustible siding <input type="checkbox"/> Manufactured (Mobile) Home <input type="checkbox"/> Metal <input type="checkbox"/> Concrete/Block <input type="checkbox"/> Other _____ Deck Present <input type="checkbox"/> YES <input type="checkbox"/> NO				
34. FOR ADDITIONAL INFORMATION ON HOW TO COMPLY WITH DEFENSIBLE SPACE CLEARANCE REQUIREMENTS, PLEASE VISIT: <p align="center">WWW.FIRE.CA.GOV</p>										

According to G.O. 95, poles and towers carrying circuits of over 750 volts must be marked as “High Voltage”. Therefore, any pole or tower so marked can be identified as supporting either a primary distribution or a transmission line. The absence of such marking should not lead one to the assumption that only low voltage (secondary distribution) is present. Nearby poles on the same circuit should be checked as the marking may have fallen off of individual poles.



**Yellow Reflective Tag
1.5" x 5.5"**

**Figure 1-6. Non-Exempt Pole Identification
Southern California Edison**



**Various Shape Tags
Indicate type of clearing**

**Figure 1-7. Non-Exempt Pole Identification
Pacific Gas and Electric**

12. Hazardous Tree Identification

Falling trees or limbs can break conductors, damage poles, towers, other structures and equipment, or cause short circuits on power lines. Except in unusual circumstances (extreme weather conditions, etc.), healthy live trees seldom cause such problems. Yet trees are subject to injury, disease, insect and fungus attacks and ultimately death. When so significantly afflicted, they may become hazardous to power lines or any other improvements.

Most defects are readily apparent to the trained observer. However, some defects cannot be detected with a cursory glance. This chapter describes and illustrates some of the more common tree defects and ways to locate and evaluate them.

In applying guidelines and standards, an inspector should always bear in mind the fact that in areas with trees, whether natural or planted, the presence of power lines introduces a degree of risk. The goal of the inspector and the electric utility is to mitigate that risk in order to prevent fires, with sound judgment and experience

12.1 Recognizing Potential Root Defects

- A. Undermined or severed roots caused by erosion or construction activity and roots loosened by saturated soils and winds resulting in 25% or more root exposure.
- B. When grade is altered and 25% or more of the root system and/or the trunk of the tree is buried.
- C. Root rot is a major cause of uprooted trees. Root rot can often be detected in hardwoods by open butt rot wounds at the ground line. In conifers, it is indicated by excessive casting of exterior needles, yellowing, abnormally short needles and internodes, rounding off of the upper crown, and fungus fruiting structures in the cambium layer at the root crown (ground level or on the trunk of the tree).
- D. Root rot may also cause leaning trees.

Defective roots are particularly dangerous because of the risk they pose. ALL OR PART OF THE ENTIRE TREE MAY FALL, CAUSING SERIOUS INJURY TO PEOPLE OR DAMAGE TO PROPERTY. All or part of the entire tree may fall, causing injury to people or damage to property, particularly during high winds.

13. Leaning Trees

Trees that lean toward utility facilities can be hazardous when there is a potential for failure of either the roots, butt or bole, that results in contact with and/or damage to utility equipment. Many leaning trees are caused by outside factors (wind, soil conditions, etc.) which loosen or break the roots. Construction activities which sever roots or strike tree butts and boles also may cause trees to lean, as does the impact of falling trees, either natural or man caused. Humps and soil mounding on the opposite side of the lean direction are indicators of broken or loosened tree roots. If corrective thinning will result in additional lean potential, consideration should be-given to removal.

A leaning tree can be more hazardous because of the presence of open fire wounds or cankers, especially if accompanied by rot. Wounds facing toward or directly opposite the direction of the lean tend to have the greatest weakening effect.

14.1 Heart Rot

Heart rot/butt rot is a problem in mature and over-mature trees and frequently is an underlying cause of failure. In hardwoods, failures occur often in branches or in crotches rather than in the bole, but potential bole failures should not be overlooked

Basal fire scars and mechanical injury to the bole are a major entry point for butt and heart rot. Species especially susceptible to this kind of defect are non-resinous conifers such as white fir. When examining these species, it is very important that fire scars are checked for the presence and amount of decay.

14.1 Recognizing Heart Rot

- A. Open wounds showing visible rot.
- B. Old wounds that have partially or fully healed over.
- C. Conks anywhere on the bole of the tree
- D. Hollow trunks detected by rapping on the tree trunk or by use of an increment borer.
- E. Decreasing crown vigor.
- F. Cracks or splits not caused by lightning; and
- G. Swelling or cankers on the bole.

14.2 Degree of Hazard from Heart Rot or Butt Rot

- A. Amount of radial wood remaining.
- B. Basic form of the tree relative to weight distribution.
- C. Rate of growth vs. the loss of strength due to decay.
- D. Orientation to the prevailing winds and the amount of canopy the tree has.
- E. Other contributing factors (cracks, sap rot, leaning, root rot).

15. Trunk Deformities

Deformities can weaken the bole and increase the chance of breakage at the point of deformity. Deformations are caused by the following:

15.1 Dwarf Mistletoe Cankers

Swellings of the bole resulting from infection by dwarf-mistletoe are quite prevalent on both white and red firs. When these swellings first begin there is minimal weakening of the trunk. As the cambium in the oldest part of the swelling dies, structural weakening becomes more prevalent. Breakage at the canker location is likely to occur when the width of the dead face approaches half the circumference of these swellings. Trees in this condition should be abated. Cankers or otherwise flattened areas oriented to the windward or to the leeward side of the bole are more likely to fail than similar areas oriented parallel to the direction of strong winds.

Open dwarf-mistletoe cankers are sometimes found on the lower trunks of Ponderosa and Jeffrey pines, but resin infiltration prevents the wood from decaying. Therefore, such mistletoe cankers on these species have a lower likelihood of being hazardous, but should still be closely evaluated since some structural weakness might be possible.

Cankers, thought to result from infection by rust fungi, occur in pines. The wood around these cankers may remain sound for years, but trees with such cankers could eventually develop structural weaknesses, particularly when the depression is deep and located sixteen feet or more above the base of the tree.

15.2 Man Caused Deformities

Flattening of the tree trunk may be caused by the attachment of pieces of wood or steel members to trees to serve as cross arms for utility lines or for use as building supports. Fastening wires and cables around the trunk for various purposes deforms and weakens the tree. The guidelines for cankers and rusts can be used for evaluating risk.

15.3 Forked Trees

Forked trees with tight v-shaped crotches are susceptible to splitting and breaking off at the crotch. This problem is prevalent mostly in mature trees in which the members of the fork have grown long and heavy. Hardwoods are more susceptible to this type of failure than conifers because of their wide, spreading crown which results in strong leverage at the crotch and other points of potential weakness.

The inspector should scrutinize forked trees carefully for signs of visible open cracks and splits, included bark, or for callus ridges outlining and closing older cracks. He should also look closely for signs of rot which follow such splits. Even in the absence of splits, rot is sometimes present in crotches to a degree sufficient to render the tree hazardous.

15.4 Combination Defects

When more than one defect or condition influencing the degree of hazard is present in a tree, it is said to have a combination or multiple defects. Although single defects can be severe enough to require abatement, usually a combination of factors or a heightened level of severity of a particular defect or set of defects is more likely to trigger a decision to abate the condition. Therefore, the inspector must always look at the overall situation.

16. Defective Limbs

Limb failure can occur when the combined forces exerted on the limb exceed the strength of the limb at its weakest point. These forces include the weight of the limb itself, as well as the forces imposed by wind, snow, ice and rain such that when the tree is re-examined following winter conditions, limb configuration and relative strength could be altered. Limb failures also occur as a result of the presence of defects such as: decay, cracks, splits and breaks, holes from animals, birds (mostly woodpeckers) or insect activities and compression defect.

Hardwoods as a group are more susceptible to limb failures than are conifers because of basic differences in crown form, which in the hardwoods give rise to narrow, structurally weak crotches and also to long branches which become heavily weighted at the extremities. There is a tendency in hardwoods for trunk rot to extend into major limbs and increase the potential for limb failures. In this regard true oaks, eucalyptus and sycamore merit special attention.

16.1 Size of Limbs

A degree of hazard control can be achieved by removal of defective limbs larger than a specified diameter and length. The detailed guidelines which follow are based on this concept.

16.2 Location of Limbs

A basic principle in tree hazard control is that a potential hazard exists only if there is a likelihood of injury or damage should a tree, or part of a tree, fail. Before a situation can be said to be potentially hazardous from tree limbs, two basic elements must be present: (a) defective limbs larger than a specified diameter and length (see 16.5), and (b) limbs located so that in falling they have a likelihood of striking power lines.

16.3 Relative Durability of Wood

Dead limbs of most conifers will remain attached for a relatively long time in a safe condition because of their resinous character which renders the limbs resistant to decay. The exception to this exists with the dead wood of the true firs which, due to its non-resinous character, can be expected to decay faster than the dead limbs of other coniferous species. Consequently, the true firs and other conifers should be inspected with these facts in mind.

Dead limbs of hardwoods generally decay faster than do similar limbs in conifers. This faster rate of decay in turn means more rapid development of defective limbs in hardwoods than in conifers.

16.4 Weather Conditions

Weather conditions have an important influence on the number of dead and defective limbs in a tree. Limbs which have withstood snow and ice loads the previous winter are less likely to break and fall later during the milder weather. Many weak and defective limbs are eliminated under snow and ice conditions. This natural testing and elimination of defective and weak limbs does not occur in trees below the snowline: consequently, the limb hazard potential can be greater in such areas.

16.5 Guidelines for Dead Limb Hazard Control

- A. Conifers - Remove dead tops and limbs when:
 - 1. Defects and weakness exist as a result of decay, breaking, cracking, splitting, wood pecker holes or insect activity.
 - 2. Limb size exceeds 3 inches in diameter and 6 feet in length.
- B. Hardwood - [Except true oak and madrone]
 - 1. Remove all dead tops and limbs the same as for conifers.
- C. True oak and madrone
 - 1. Remove all dead tops and limbs, when limb size exceeds 2 inches in diameter and 4 feet in length.

17. Top Defects

17.1 Dead Tops

Dead tops on living conifers, sometimes called "spike tops", may be hazardous in some cases. Experience indicates that spike tops in Sierra redwood, incense cedar, coast redwood, pines and Douglas fir can be considered non hazardous if not structurally weakened by defects such as bad cracks, splits or woodpecker holes, and also, if without bark, which could loosen and fall.

Dead tops in both White and California red firs must be considered hazardous, and such tops should be removed as soon as possible. Because of the non-resinous nature of the wood of these species, it is relatively non-durable and quite susceptible to attack and consequent weakening by decay fungi.

17.2 Broken Out Tops and Volunteer Tops

Conifers with tops that have broken out are not considered to be hazardous, even though there may be rot present below the break and a short length of decayed trunk still remains. Volunteer tops that form following the loss of tops in conifers are not considered hazardous so long as such tops remain live. This is true whether such tops are single or multiple. When dead, such tops should be considered a hazard and should be removed.

18. Other Considerations

18.1 Thick Crown Growth

Crowns with a heavy, thick growth of live limbs and branches may be susceptible to limb failure (as well as bole and root failure) from winds. Corrective pruning may be justified to prevent such failures

18.2 Structure

The overall structure of many hardwoods, as well as some conifers, frequently includes a combination of potentially weak crotches and heavy limbs which render the limbs susceptible to failure at the crotches. Sometimes open cracks or callus ridges may be present as evidence of partial failure, but frequently no such evidence is visible. Through observation and experience, the inspector should come to recognize such potentially hazardous conditions. General pruning to reduce limb and crown weight should be considered for control.

19. Techniques and Aids

The inspector should develop certain habits when checking for hazardous trees. Few defects are located at eye-level; therefore, he/she must quickly scan the entire tree from the soil surrounding it to the top and the branches. Many conifers are over 100 feet tall, making naked eye inspection of the top and upper branches somewhat difficult, thus binoculars should be part of his or her equipment.

If any indication is noted of butt, heart or sapwood rot in the lower trunk, the extent of damage should be estimated. A quick, rough estimate can be made by tapping the trunk with an ax handle, night stick, or other similar instrument to determine whether or not it sounds hollow. An increment borer may also be used.

He/she should check the orientation of conks, flat areas, splits, crotches and other deformities in relation to the direction of the power line from the tree and to the prevailing wind direction. If the tree, or a part thereof, does not require abatement the inspector should go on to the next tree.

When a tree is found which needs treatment, it must be properly identified for those who will do the work and for follow-up inspection. The tree should be marked with flagging, timber-marking paint or other means. It should be located by map, sketch, or bearing and distance from an identifiable object. In some cases, one or more photographs would be helpful.

An inspector should develop the habit of looking to both sides and to the rear as well as ahead. Many defective trees will be hidden from one direction but not from other directions. Similarly, many defects can only be seen from one or two sides of the tree.

Finally, in particularly in dense stands, the inspector should make occasional side trips outside the cleared right-of-way. This is particularly true in dense conifer stands. The screening vegetation along the edges of the right-of-way will often hide evidence of defects in trees.

Statutes and Regulations State Laws

This document has been designed to present only those laws and regulations, or portions thereof, which pertain more or less directly to power line fire prevention in California. As such, this document should only be used as a quick reference. For full and current text, meaning and proper context of laws and regulations, reference should be made to applicable codes, manuals, directives, etc.

Public Resources Code

Section 4021

Penalty

Except as otherwise provided, the willful or negligent commission of any of the acts prohibited or the omission of any of the acts required by Chapter 2 (commencing with Section 4251) to Chapter 6 (commencing with Section 4411), inclusive, of Part 2 of this division is a misdemeanor.

Section 4101

“Person” Defined

“Person” includes any agency of the state, county, city, district or other local public agency and any individual, firm, association, partnership, business trust, corporation or company.

Note: This definition includes publicly-owned utilities (e.g. REA’s, SMUD, L.A. Dept. of Water and Power, etc.). It does not include federal agencies (e.g. Bureau of Reclamation, U.S. Army Corps of Engineers, etc.).

Section 4117

Local Ordinance

Any county, city, or district may adopt ordinances, rules or regulations to provide fire prevention regulations that are necessary to meet local conditions of weather, vegetation, or other fire hazards. Such ordinances, rules or regulations may be more restrictive than state statutes in order to meet local fire conditions.

Section 4119

Enforcing State Forest and Fire Laws Duty of State Officer

The Director of Forestry and Fire Protection, or his duly authorized agent, shall enforce the state forest and fire laws. He may inspect all properties, except the interior of dwellings, subject to the state forest and fire laws, for the purpose of ascertaining compliance with such laws.

Note: By interagency agreement, many employees of the U.S. Forest Service, Bureau of Land Management, National Park Service and certain county fire departments are "duly authorized agents" of the Director of Forestry and Fire Protection.

Section 4125

Classification of Lands as State Responsibility Areas for Fire Protection

The board shall classify all lands within the state, without regard to any classification of lands made by or for any federal agency or purpose, for the purpose of determining areas in which the financial responsibility of the state. The prevention and suppression of fires in all areas which are not so classified is primarily the responsibility of local or federal agencies, as the case may be.

Note: Specific Regulations under this Section can be found in Title 14 Sections 1220-1220.5, California Administrative Code.

Section 4126

State Responsibility Areas: Lands Included

The board shall include within state responsibility areas all of the following lands:

- (a) Lands covered wholly or in part by forests or by trees producing or capable of producing forest products.
- (b) Lands covered wholly or in part by timber, brush, undergrowth or grass, whether of commercial value or not, which protect the soil from excessive erosion, retard runoff of water or accelerate water percolation, if such lands are sources of water which is available for irrigation or for domestic or industrial use.
- (c) Lands in areas which are principally used or useful for range or forage purposes, which are contiguous to the lands described in subdivisions (a) and (b).

Note: Specific Regulations under this Section can be found in Title 14, Sections 1220-1220.5, California Administrative Code.

Section 4127

State Responsibility Areas: Lands Excluded

The board shall not include within this state responsibility areas any of the following lands:

- (a) Lands owned or controlled by the federal government or any agency of the federal government.
- (b) Lands within the exterior boundaries of any city.
- (c) Any other lands within the state which do not come within any of the classes which are described in Section 4126.

Note: Specific Regulations under this Section can be found in Title 14, Sections 1220-1220.5, California Administrative Code.

Section 4128

State Responsibility Areas: Boundaries

In establishing boundaries of state responsibility areas, the board may, for purposes of administrative convenience, designate roads, pipelines, streams or other recognizable landmarks as arbitrary boundaries.

Note: Specific Regulations under this Section can be found in Title 14, Sections 1220-1220.5, California Administrative Code.

Section 4171

Public Nuisances Defined

Any condition endangering public safety by creating a fire hazard and which exists upon any property which is included within any state responsibility area is a public nuisance.

Section 4202

The director shall classify lands within state responsibility areas into fire hazard severity zones. Each zone shall embrace relatively homogeneous lands and shall be based on fuel loading, slope, fire weather, and other relevant factors present, including areas where winds have been identified by the department as a major cause of wildfire spread.

Section 4290

Regulations Implementing Minimum Fire Safety Standards Related to Defensible Space Applicable to State Responsibility Lands

The board shall adopt regulations implementing minimum fire safety standards related to defensible space which are applicable to state responsibility area lands under the authority of the department. These regulations apply to the perimeters and access to all residential, commercial, and industrial building construction within state responsibility areas approved after July 1, 1989. The board may not adopt building standards, as defined in Section 18909 of the Health and Safety Code, under the authority of this section. As an integral part of fire safety standards, the State Fire Marshal has the authority to adopt regulations for roof coverings and openings into the attic areas of buildings specified in Section 13108.5 of the Health and Safety Code. The regulation apply to the placement of mobile homes as defined by National Fire Protection Association standards. These regulations do not apply where an application for a building permit was filed prior to July 1, 1989, or to parcel or tentative maps or other developments approved prior to July 1, 1989, if the final map for the tentative map is approved within the time prescribed by the local ordinance. The regulations shall include all of the following:

- (a) Road standards for fire equipment access.
- (b) Standards for signs identifying streets, roads, and buildings.
- (c) Minimum private water supply reserves for emergency fire use.
- (d) Fuel breaks and greenbelts.

These regulations do not supersede local regulations which equal or exceed minimum regulations adopted by the state.

Section 4291

- (a) A person who owns, leases, controls, operates, or maintains a building or structure in, upon, or adjoining a mountainous area, forest-covered lands, brush-covered lands, grass-covered lands, or land that is covered with flammable material, shall at all times do all of the following:

(1) Maintain defensible space no greater than 100 feet from each side of the structure, but not beyond the property line unless allowed by state law, local ordinance, or regulation and as provided in paragraph (2). The amount of fuel modification necessary shall take into account the flammability of the structure as affected by building material, building standards, location, and type of vegetation. Fuels shall be maintained in a condition so that a wildfire burning under average weather conditions would be unlikely to ignite the structure. This paragraph does not apply to single specimens of trees or other vegetation that are well-pruned and maintained so as to effectively manage fuels and not form a means of rapidly transmitting fire from other nearby vegetation to a structure or from a structure to other nearby vegetation. The intensity of fuels management may vary within the 100-foot perimeter of the structure, the most intense being within the first 30 feet around the structure. Consistent with fuels management objectives, steps should be taken to minimize erosion.

(2) A greater distance than that required under paragraph (1) may be required by state law, local ordinance, rule, or regulation. Clearance beyond the property line may only be required if the state law, local ordinance, rule, or regulation includes findings that such a clearing is necessary to significantly reduce the risk of transmission of flame or heat sufficient

to ignite the structure, and there is no other feasible mitigation measure possible to reduce the risk of ignition or spread of wildfire to the structure. Clearance on adjacent property shall only be conducted following written consent by the adjacent landowner.

- (3) An insurance company that insures an occupied dwelling or occupied structure may require a greater distance than that required under paragraph (1) if a fire expert, designated by the director, provides findings that such a clearing is necessary to significantly reduce the risk of transmission of flame or heat sufficient to ignite the structure, and there is no other feasible mitigation measure possible to reduce the risk of ignition or spread of wildfire to the structure. The greater distance may not be beyond the property line unless allowed by state law, local ordinance, rule, or regulation.
- (4) Remove that portion of any tree that extends within 10 feet of the outlet of a chimney or stovepipe.
- (5) Maintain any tree, shrub, or other plant adjacent to or overhanging a building free of dead or dying wood.
- (6) Maintain the roof of a structure free of leaves, needles, or other vegetative materials.
- (7) (a) Prior to constructing a new building or structure or rebuilding a building or structure damaged by a fire in an area subject to this section, the construction or rebuilding of which requires a building permit, the owner shall obtain a certification from the local building official that the dwelling or structure, as proposed to be built, complies with all applicable state and local building standards, including those described in subdivision (b) of Section 51189 of the Government Code, and shall provide a copy of the certification, upon request, to the insurer providing course of construction insurance coverage for the building or structure. Upon completion of the construction or rebuilding, the owner shall obtain from the local building official, a copy of the final inspection report that demonstrates that the dwelling or structure was constructed in compliance with all applicable state and local building standards, including those described in subdivision (b) of Section 51189 of the Government Code, and shall provide a copy of the report, upon request, to the property insurance carrier that insures the dwelling or structure.

(b) A person is not required under this section to manage fuels on land if that person does not have the legal right to manage fuels, nor is a person required to enter upon or to alter property that is owned by any other person without the consent of the owner of the property.

(c) (1) Except as provided in Section 18930 of the Health and Safety Code, the director may adopt regulations exempting a structure with an exterior constructed entirely of non flammable materials, or, conditioned upon the contents and composition of the structure, the director may vary the requirements respecting the removing or clearing away of flammable vegetation or other combustible growth with respect to the area surrounding those structures.

(2) An exemption or variance under paragraph (1) shall not apply unless and until the occupant of the structure, or if there is not an occupant, the owner of the structure, files with the department, in a form as the director shall prescribe, a written consent to the inspection of the interior and contents of the structure to ascertain whether this section and the regulations adopted under this section are complied with at all times.

(d) The director may authorize the removal of vegetation that is not consistent with the standards of this section. The director may prescribe a procedure for the removal of that vegetation and make the expense a lien upon the building, structure, or grounds, in the same manner that is applicable to a legislative body under Section 51186 of the Government Code.

(e) The Department of Forestry and Fire Protection shall develop, periodically update, and post on its Internet Web site a guidance document on fuels management pursuant to this chapter. Guidance shall include, but not be limited to, regionally appropriate vegetation management suggestions that preserve and restore native species, minimize erosion, minimize water consumption, and permit trees near homes for shade, aesthetics, and habitat; and suggestions to minimize or eliminate the risk of flammability of nonvegetative sources of combustion such as woodpiles, propane tanks, wood decks, and outdoor lawn furniture.

(f) As used in this section, "person" means a private individual, organization, partnership, limited liability company, or corporation.

Section 4292

Power Line Hazard Reduction

Except as otherwise provided in Section 4296, any person that owns, controls, operates, or maintains any electrical transmission or distribution line upon any mountainous land, or forest-covered land, brush-covered land, or grass-covered land shall, during such times and in such areas as are determined to be necessary by the director or the agency which has primary responsibility for fire protection of such areas, maintain around and adjacent to any pole or tower which supports a switch, fuse, transformer, lightning arrester, line junction, or dead end or corner pole, a firebreak which consists of a clearing of not less than 10 feet in each direction from the outer circumference of such pole or tower. This section does not, however, apply to any line which is used exclusively as telephone, telegraph, telephone or telegraph messenger call, fire or alarm line, or other line which is classed as a communication circuit by the Public Utilities Commission. The director or the agency which has primary fire protection responsibility for the protection of such areas may permit exceptions from the requirements of this section which are based upon the specific circumstances involved.

Section 4293

Power Line Clearance Required

Except as otherwise provided in Sections 4294 to 4296, inclusive, any person that owns, controls, operates, or maintains any electrical transmission or distribution line upon any mountainous land, or in forest-covered land, brush-covered land, or grass-covered land shall, during such times and in such areas as are determined to be necessary by the director or the agency which has primary responsibility for the fire protection of such areas, maintain a clearance of the respective distances which are specified in this section in all directions between all vegetation and all conductors which are carrying electric current:

- (a) For any line which is operating at 2,400 or more volts, but less than 72,000 volts, four feet.
- (b) For any line which is operating at 72,000 or more volts, but less than 110,000 volts, six feet.
- (c) For any line which is operating at 110,000 or more volts, 10 feet.

In every case, such distance shall be sufficiently great to furnish the required clearance at any position of the wire, or conductor when the adjacent air temperature is 120 degrees Fahrenheit, or less. Dead trees, old decadent or rotten trees, trees weakened by decay or disease and trees

or portions thereof that are leaning toward the line which may contact the line from the side or may fall on the line shall be felled, cut, or trimmed so as to remove such hazard. The director or the agency which has primary responsibility for the fire protection of such areas may permit exceptions from the requirements of this section which are based upon the specific circumstances involved.

Section 4294

Aerial Cable

A clearing to obtain line clearance is not required if self-supporting aerial cable is used. Forked trees, leaning trees, and any other growth which may fall across the line and break it shall, however, be removed.

Section 4295

Clearance Not Required

A person is not required by Section 4292 or 4293 to maintain any clearing on any land if such person does not have the legal right to maintain such clearing, nor do such sections require any person to enter upon or to damage property which is owned by any other person without the consent of the owner of the property.

Section 4296

Low Voltage Lines

Sections 4292 and 4293 do not apply if the transmission or distribution line voltage is 750 volts or less.

Section 4435

Origination of Fire-Negligence

If any fire originates from the operation or use of any engine, machine, barbecue, incinerator, railroad rolling stock, chimney or other device which may kindle a fire, the occurrence of the fire is prima facie evidence of negligence in the maintenance, operation, or use of such engine, machine, barbecue, incinerator, railroad rolling stock, chimney or other device. If such fire escapes from the place where it originated and it can be determined which person's negligence caused such a fire, such person is guilty of a misdemeanor.

Government Code

51175.

- (a) Wildfires are extremely costly, not only to property owners and residents, but also to local agencies. Wildfires pose a serious threat to the preservation of the public peace, health, or safety. The wildfire front is not the only source of risk since embers, or firebrands, travel far beyond the area impacted by the front and pose a risk of ignition to a structure or fuel on a site for a longer time. Since fires ignore civil boundaries, it is necessary that cities, counties, special districts, state agencies, and federal agencies work together to bring raging fires under control. Preventive measures are therefore needed to ensure the preservation of the public peace, health, or safety.
- (b) The prevention of wildland fires is not a municipal affair, as that term is used in Section 5 of Article XI of the California Constitution, but is instead, a matter of statewide concern. It is the intent of the Legislature that this chapter applies to all local agencies, including, but not limited to, charter cities, charter counties, and charter cities and counties. This subdivision shall not limit the authority of a local agency to impose more restrictive fire and public safety requirements, as otherwise authorized by law.
- (c) It is not the intent of the Legislature in enacting this chapter to limit or restrict the authority of a local agency to impose more restrictive fire and public safety requirements, as otherwise authorized by law.

51177

- (a) "Defensible space" means the area adjacent to a structure or dwelling where wildfire prevention or protection practices are implemented to provide defense from an approaching wildfire or to minimize the spread of a structure fire to wildlands or surrounding areas.
- (b) "Director" means the Director of Forestry and Fire Protection.
- (c) "Fuel" means any combustible material, especially petroleum-based products and wildland fuels.
- (d) "Fuel management" means the act or practice of controlling flammability and reducing resistance to control of fuels through mechanical, chemical, biological, or manual means or by fire, in support of land management objectives.
- (e) "Local agency" means a city, county, city and county, or district responsible for fire protection within a very high fire hazard severity zone.
- (f) "Single specimen tree" means any live tree that stands alone in the landscape so as to be clear of buildings, structures, combustible vegetation, or other trees, and that does not form a means of rapidly transmitting fire from the vegetation to an occupied dwelling or structure or from an occupied dwelling or structure to vegetation.
- (g) "State responsibility areas" means those areas identified pursuant to Section 4102 of the Public Resources Code.
- (h) "Vegetation" means all plants, including trees, shrubs, grass, and perennial or annual plants.
- (i) "Very high fire hazard severity zone" means an area designated by the director pursuant to Section 51178 that is not a state responsibility area.
- (j) "Wildfire" means an unplanned, unwanted wildland fire, including unauthorized human-caused fires, escaped wildland fire use events, escaped prescribed fire projects, and all other wildland fires where the objective is to extinguish the fire.

51178

The director shall identify areas in the state as very high fire hazard severity zones based on consistent statewide criteria and based on the severity of fire hazard that is expected to prevail in those areas. Very high fire hazard severity zones shall be based on fuel loading, slope, fire weather, and other relevant factors including areas where Santa Ana, Mono, and Diablo winds have been identified by the Department of Forestry and Fire Protection as a major cause of wildfire spread.

51182

- (a) A person who owns, leases, controls, operates, or maintains an occupied dwelling or occupied structure in, upon, or adjoining any mountainous area, forest-covered land, brush-covered land, grass-covered land, or any land that is covered with flammable material, which area or land is within a very high fire hazard severity zone designated by the local agency pursuant to Section 51179, shall at all times do all of the following:
- (1) Maintain defensible space no greater than 100 feet from each side of the structure, but not beyond the property line unless allowed by state law, local ordinance, or regulation and as provided in paragraph (2). The amount of fuel modification necessary shall take into account the flammability of the structure as affected by building material, building standards, location, and type of vegetation. Fuels shall be maintained in a condition so that a wildfire burning under average weather conditions would be unlikely to ignite the structure. This paragraph does not apply to single specimens of trees or other vegetation that are well-pruned and maintained so as to effectively manage fuels and not form a means of rapidly transmitting fire from other nearby vegetation to a structure or from a structure to other nearby vegetation. The intensity of fuels management may vary within the 100-foot perimeter of the structure, the most intense being within the first 30 feet around the structure. Consistent with fuels management objectives, steps should be taken to minimize erosion.
 - (2) A greater distance than that required under paragraph (1) may be required by state law, local ordinance, rule, or regulation. Clearance beyond the property line may only be required if the state law, local ordinance, rule, or regulation includes findings that such a clearing is necessary to significantly reduce the risk of transmission of flame or heat sufficient to ignite the structure, and there is no other feasible mitigation measure possible to reduce the risk of ignition or spread of wildfire to the structure. Clearance on adjacent property shall only be conducted following written consent by the adjacent landowner.
 - (3) An insurance company that insures an occupied dwelling or occupied structure may require a greater distance than that required under paragraph (1) if a fire expert, designated by the fire chief or fire official from the authority having jurisdiction, provides findings that such a clearing is necessary to significantly reduce the risk of transmission of flame or heat sufficient to ignite the structure, and there is no other feasible mitigation measure possible to reduce the risk of ignition or spread of wildfire to the structure. The greater distance may not be beyond the property line unless allowed by state law, local ordinance, rule, or regulation.
 - (4) Remove that portion of any tree that extends within 10 feet of the outlet of any chimney or stovepipe.
 - (5) Maintain any tree, shrub, or other plant adjacent to or overhanging any building free of dead or dying wood.
 - (6) Maintain the roof of any structure free of leaves, needles, or other vegetative materials.
 - (7) Prior to constructing a new dwelling or structure that will be occupied or rebuilding an occupied dwelling or occupied structure damaged by a fire in that zone, the construction or

rebuilding of which requires a building permit, the owner shall obtain a certification from the local building official that the dwelling or structure, as proposed to be built, complies with all applicable state and local building standards, including those described in subdivision (b) of Section 51189, and shall provide a copy of the certification, upon request, to the insurer providing course of construction insurance coverage for the building or structure. Upon completion of the construction or rebuilding, the owner shall obtain from the local building official, a copy of the final inspection report that demonstrates that the dwelling or structure was constructed in compliance with all applicable state and local building standards, including those described in subdivision (b) of Section 51189, and shall provide a copy of the report, upon request, to the property insurance carrier that insures the dwelling or structure.

- (b) A person is not required under this section to manage fuels on land if that person does not have the legal right to manage fuels, nor is a person required to enter upon or to alter property that is owned by any other person without the consent of the owner of the property.
- (c) The Department of Forestry and Fire Protection shall develop, periodically update, and post on its Internet Web site a guidance document on fuels management pursuant to this chapter. Guidance shall include, but not be limited to, regionally appropriate vegetation management suggestions that preserve and restore native species, minimize erosion, minimize water consumption, and permit trees near homes for shade, aesthetics, and habitat, and suggestions to minimize or eliminate the risk of flammability of nonvegetative sources of combustion such as woodpiles, propane tanks, wood decks, and outdoor lawn furniture.

51183

- (a) The local agency may exempt from the standards set forth in Section 51182 structures with exteriors constructed entirely of nonflammable materials, or conditioned upon the contents and composition of the structure, and may vary the requirements respecting the management of fuels surrounding the structures in those cases. This subdivision does not authorize a local agency to vary a requirement that is a building standard subject to Section 18930 of the Health and Safety Code, except as otherwise authorized by law.
- (b) An exemption or variance under subdivision (a) shall not apply unless and until the occupant of the structure, or if there is no occupant, then the owner of the structure, files with the local agency a written consent to the inspection of the interior and contents of the structure to ascertain whether Section 51182 is complied with at all times.

51189

- (a) The Legislature finds and declares that site and structure defensibility is essential to reduce the risk of structure ignition as well as for effective fire suppression by firefighters. This need to establish defensibility extends beyond the site fuel management practices required by this chapter, and includes, but is not limited to, measures that increase the likelihood of a structure to withstand ignition, such as building design and construction requirements that use fire resistant building materials, and provide standards for reducing fire risks on structure projections, including, but not limited to, porches, decks, balconies and eaves, and structure openings, including, but not limited to, attic, foundation, and eave vents, doors, and windows.
- (b) No later than January 1, 2005, the State Fire Marshal, in consultation with the Director of Forestry and Fire Protection and the Director of Housing and Community Development, shall, pursuant to Section 18930 of the Health and Safety Code, recommend building standards that provide for comprehensive site and structure fire risk reduction to protect structures from fires spreading from adjacent structures or vegetation and to protect vegetation from fires spreading from adjacent structures.

Health and Safety Code

Section 13001

Causing Fire

Misdemeanor. Every person is guilty of a misdemeanor who, through careless or negligent action, throws or places any lighted cigarette, cigar, ashes, or other flaming or glowing substance, or any substance or thing which may cause a fire, in any place where it may directly or indirectly start a fire, or who uses or operates a welding torch, tar pot or any other device which may cause a fire, who does not clear the inflammable material surrounding the operation or take such other reasonable precautions necessary to insure against the starting and spreading of fire.

Section 13007

Liability for Damage

Any person who personally or through another willfully, negligently or in violation of law, sets fire to, allows fire to be set to or allows a fire kindled or attended by him to escape to, the property of another, whether privately or publicly owned, is liable to the owner of such property for any damages to the property caused by the fire

Section 13009

Suppression Cost Collectible

- (a) Any person who negligently, or in violation of the law, sets a fire, allows a fire to be set or allows a fire kindled or attended by him to escape onto any forest, range, or non-residential grass-covered land is liable for the expense of fighting the fire and such expense shall be a charge against that person. Such charge shall constitute a debt of such person and is collectible by the person, or by the federal, state, county, public or private agency, incurring such expenses in the same manner as in the case of an obligation under a contract, expressed or implied.
- (b) Public agencies participating in fire suppression, rescue or emergency medical services as set forth in subdivision (a) may designate one or more participating agencies to bring an action to recover costs incurred by all of the participating agencies. An agency designated by the other participating agencies to bring an action pursuant to this section shall declare that authorization and its basis in the complaint, and shall itemize in the complaint the total amounts claimed under this section by each represented agency.
- (c) Any costs incurred by the Department of Forestry in suppressing any wildland fire originating or spreading from a prescribed burning operation conducted by the department pursuant to a contract entered into pursuant to Article 2 (commencing with Section 4475) of Chapter 7 of Part 2 of Division 4 of the Public Resources Code shall not be collectible from any party to the contract, including any private consultant or contractor who entered into an agreement with that party pursuant to subdivision (d) of Section 4475.5 of that code, as provided in subdivision (a), to the extent that those costs were not incurred as a result of a violation of any provision of the contract.
- (d) This section applies to all areas of the state, regardless of whether primarily wildlands, sparsely developed, or urban.

Section 13009.1

Liability of person who negligently sets fire; Burden of proof; Limitation on use of evidence.

- (a) Any person (1) who negligently, or in violation of the law, sets a fire, allows a fire to be set or allows a fire kindled by him or her to escape onto any public or private property is liable for both of the following:
- (1) The cost of investigating and making any reports with respect to the fire.
 - (2) The costs relating to accounting for that fire and the collection of any funds pursuant to Section 13009, including, but not limited to, the administrative costs of operating a fire suppression cost recovery program.
- The liability imposed pursuant to this paragraph is limited to the actual amount expended which is attributable to the fire.
- (b) In any civil action brought for the recovery of costs provided in this section, the court in its discretion may impose the amount of liability for costs described in subdivision (a).
- (c) The burden of proof as to liability shall be on the plaintiff and shall be by a preponderance of the evidence in an action alleging that the defendant is liable for costs pursuant to this section. The burden of proof as to the amount of costs recoverable shall be on the plaintiff and shall be by a preponderance of the evidence in any action brought pursuant to this section.
- (d) Any testimony, admission, or any other statement made by the defendant in any proceeding brought pursuant to this section, or any evidence derived from the testimony, admission or other statement, shall not be admitted or otherwise used in any criminal proceeding arising out of the same conduct.
- (e) The liability constitutes a debt of that person and is collectible by the person, or by the federal, state, county, public, or private agency, incurring those costs in the same manner as in the case of an obligation under a contract, expressed or implied.
- (f) This section applies in all areas of the state, regardless of whether primarily wildlands, sparsely developed, or urban.

Section 13009.5

Charge for use of inmate labor

Where the Department of Forestry and Fire Protection utilizes labor for fighting fires, the charge for their use, for the purpose of Section 13009, shall be set by the Director of Forestry and Fire Protection. In determining the charges, he or she may consider, in addition to costs incurred by the department, the per capita cost to the state of maintaining the inmates.

Title 14, California Code of Regulations

Section 1250

Purpose

The purpose of Article 4 is to provide specific exemptions from: electric pole and tower firebreak clearance standards, electric conductor clearance standards and to specify when and where the standards apply.

Note: The Director of Cal Fire makes regulations that apply in State Responsibility Areas (SRA) on mountainous, forest covered, brush covered, or grass covered lands.

Section 1251

Definitions

The following definitions apply to this article unless the context requires otherwise:

- (a) “Conductor” means connector, a wire or a combination of wires, and/or any other appliance designed and manufactured for use in the transmission and distribution of electrical current.
- (b) “Connector” means a device approved for energized electrical connections.
- (c) “Duff” means partially decayed leaves, needles, grass or other organic material accumulated on the ground.
- (d) “Firebreak” means a natural or artificial barrier usually created by the removal or modification of vegetation and other flammable materials for the purpose of preventing the spread of fire.
- (e) “Hot line tap or clamp connector” means a connector designed to be used with a grip-All Clamp stick (Shotgun) for connecting equipment jumper or tap conductors to an energized main line or running conductor.
- (f) “Outer Circumference” means the exterior surface of a pole or tree at ground level or a series of straight lines tangent to the exterior of the legs of a tower at ground level.
- (g) “Self-supporting aerial cable” means an assembly of abrasion resistant insulated conductors supported by a messenger cable which is normally grounded, designed and manufactured to carry electrical current for installation on overhead pole lines or other similar overhead structures.
- (h) “Tree wire” means an insulated conductor covered with a high abrasion resistant, usually non-metallic, outer covering, designed and manufactured to carry electrical current for installation on overhead pole lines or other similar overhead structures.

Section 1252

Areas where PRC 4292, 4293 Apply in State Responsibility Areas.

The Director will apply PRC 4292-4296 in any mountainous land, forest-covered land, brush-covered land or grass-covered land within State Responsibility Area unless specifically exempted by 14 CCR, sections 1255 and 1257.

Note: Authority cited: Sections 4292 and 4293, Public Resources Code.

Reference : Sections 4125-4128, 4292, 4293, Public Resources Code.

Section 1252.1

Official Area Maps

The official maps of State Responsibility Areas defined in 14 CCR 1220 are available for viewing and copying during normal business hours at the California Department of Forestry and Fire Protection, 1416 Ninth Street, Sacramento, California, 95814, in the Fire Protection Section.

When pursuant to PRC 4125-4128, the Board revises State Responsibility Area boundaries, the Director will forward a legal description of a boundary change(s) to the respective electric utility(s) serving the area(s).

Note: Authority cited: Sections 4292, 4293 Public Resources Code.

Reference: Sections 4125-4128, 4292, 4293, Public Resources Code.

Section 1252.2

Boundary Location - Roads Etc.

Where the boundaries of areas described in 14, CCR 1252, are along roads, highways, streets, railroads, streams, canals or rivers, the actual boundary shall be the center-line of the course of such roads, highways, streets, railroads, streams, canals and rivers.

Note: Authority cited: Sections 4292, 4293 Public Resources Code.

Reference: Sections 4125-4128, 4292, 4293, Public Resources Code.

Section 1253

Time when PRC 4292-4296 Apply

The minimum firebreak and clearance provisions of PRC 4292-4296 are applicable during the declared California Department of forestry and Fire Protection fire season for a respective county. The Director shall post the declaration on the official Department web site.

Note: Authority sited: Sections 4292-4293, Public Resources Code.

Reference: Sections 4125-4128, 4292 and 4293, Public Resources Code.

Section 1254

Minimum Clearance Provisions PRC 4292

The firebreak clearances required by PRC 4292 are applicable within an imaginary cylindrical space surrounding each pole or tower on which a switch, fuse, transformer or lightning arrester is attached and surrounding each deadend or corner pole, unless such pole or tower is exempt from minimum clearance requirements by provisions of 14, CCR, 1255 or PRC 4296. The radius of the cylindroid is 3.1 m (10 feet) measured horizontally from the outer circumference of the specified pole or tower with height equal to the distance from the intersection of the imaginary vertical exterior surface of the cylindroid with the ground to an intersection with a horizontal plane passing through the highest point at which a conductor is attached to such pole or tower. Flammable vegetation and materials located wholly or partially within the firebreak space shall be treated as follows:

- (a) At ground level - remove flammable materials, including but not limited to, ground litter, duff and dead or desiccated vegetation that will allow fire to spread, and;
- (b) From 0 - 2.4 m (0-8 feet) above ground level remove flammable trash, debris or other materials, grass, herbaceous and brush vegetation. All limbs and foliage of living trees shall be removed up to a height of 2.4 m (8 feet).
- (c) From 2.4 m (8 feet) to horizontal plane of highest point of conductor attachment remove dead, diseased or dying limbs and foliage from living sound trees and any dead, diseased or dying trees in their entirety.

Section 1255

Exemptions to Minimum Clearance Provisions - PRC 4292

The minimum clearance provisions of PRC 4292 are not required around poles and towers, including line junction, corner and dead end poles and towers:

- (a) Where all conductors are continuous over or through a pole or tower; or
- (b) Where all conductors are not continuous over or through a pole or tower, provided, all conductors and subordinate equipment are of the types listed below and are properly installed and used for the purpose for which they were designed and manufactured;
 - (1) Compression connectors.
 - (2) Automatic connectors.
 - (3) Parallel groove connectors.
 - (4) Hot line tap or clamp connectors that were designed to absorb any expansion or contraction by applying spring tension on the main line or running conductor and tap connector.
 - (5) Fargo GA 300 series piercing connectors designed and manufactured for use with tree wire.
 - (6) Flat plate connectors installed with not less than two bolts.
 - (7) Tapered C-shaped member and wedge connectors.
 - (8) Solid blade single-phase bypass switches and solid blade single-phase disconnect switches associated with circuit reclosers, sectionalizers and line regulators.
 - (9) Equipment that is completely sealed and liquid filled.
 - (10) Current limiting, non-expulsion fuses.
- (c) On the following areas, if fire will not propagate thereon;
 - (1) Fields planted to row crops.
 - (2) Plowed or cultivated fields.
 - (3) Producing vineyards that are plowed or cultivated.

- (4) Fields in nonflammable summer fallow.
 - (5) Irrigated pasture land.
 - (6) Orchards of fruit, nut or citrus trees that are plowed or cultivated.
 - (7) Christmas tree farms that are plowed or cultivated.
 - (8) Swamp, marsh or bog land.
- (d) Where vegetation is maintained less than 30.48 cm (12 inches) in height, is fire resistant, and is planted and maintained for the specific purpose of preventing soil erosion and fire ignition.

Section 1256

Minimum Clearance Provisions - PRC 4293

Minimum clearance required by PRC 4293 shall be maintained with the specified distances measured at a right angle to the conductor axis at any location outward throughout an arc of 360 degrees.

Minimum clearance shall include:

- (1) Any position through which the conductor may move, considering, among other things, the size and material of the conductor and its span length;
- (2) Any position through which the vegetation may sway, considering, among other things, the climatic conditions, including such things as foreseeable wind velocities and temperature, and location, height and species of the vegetation.

Section 1257

Minimum Clearance Provisions - PRC 4293

The minimum clearance provisions of PRC 4293 are not required:

- (a) Where conductors are;
 - (1) Insulated tree wire, maintained with the high density, abrasion resistant outer covering intact, or,
 - (2) Insulated self-supporting aerial cable, maintained with the insulation intact, or,
- (b) On areas described in 14, CCR, 1255 (c);
- (c) Except;
 - (1) Dead and decadent or rotten trees, trees weakened by decay or disease, leaning trees and portions thereof that are leaning toward conductor(s) and any other growth which may fall across the conductor and break it are removed or trimmed to remove such hazard.
 - (2) The trunk of any tree is not required to be removed when sound and living, and is the supporting structure to which conductor(s) are attached.

Section 1258

Tree Lines

When electric conductors and subordinate elements are fastened to living, sound trees, commonly referred to as tree lines, the requirements of PRC 4292 and 4293 shall apply the same as to a pole or tower line.

Figure 1-8
PRC 4292
14 CCR 1251
Definition of Outer Circumference Examples
(Plan View at Ground Level)

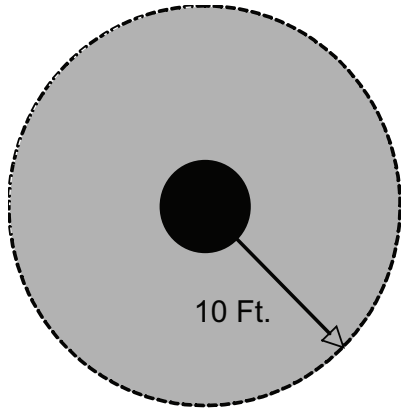

Pole

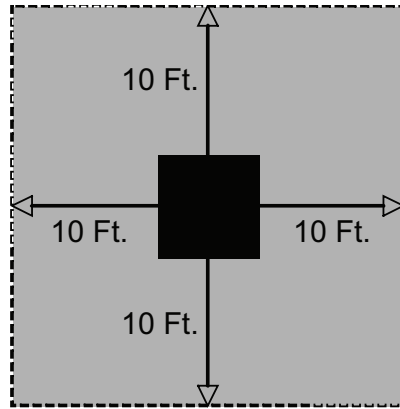

Single Leg Tower

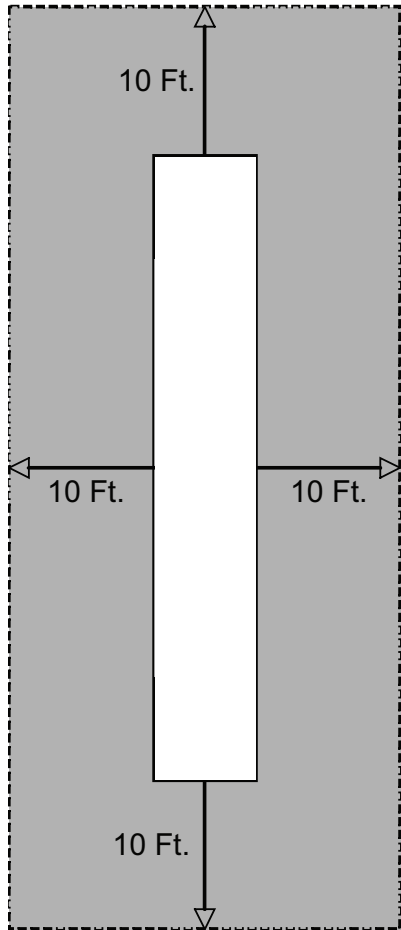

Two Leg Tower

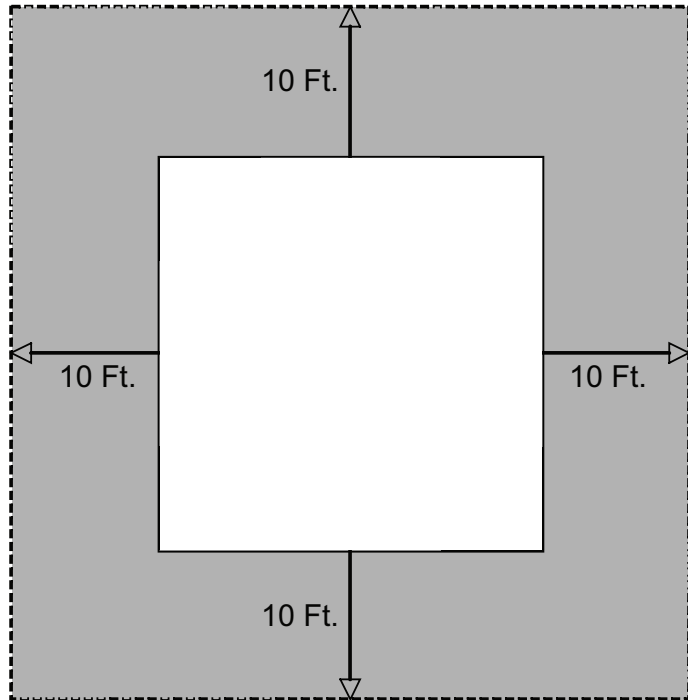

Four Leg Tower

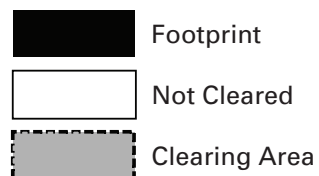

Northern Region



Figure 1-9

The minimum firebreak and clearance provisions of PRC 4292 - 4296 are applicable during the declared California Department of Forestry and Fire protection fire season for a respective county. The Director shall post the declaration on the official Department web site.



Southern Region

Contract County

Figure 1-10
PRC 4292
14 CCR 1254
Fire Break Clearance Requirements
Around Poles and Towers

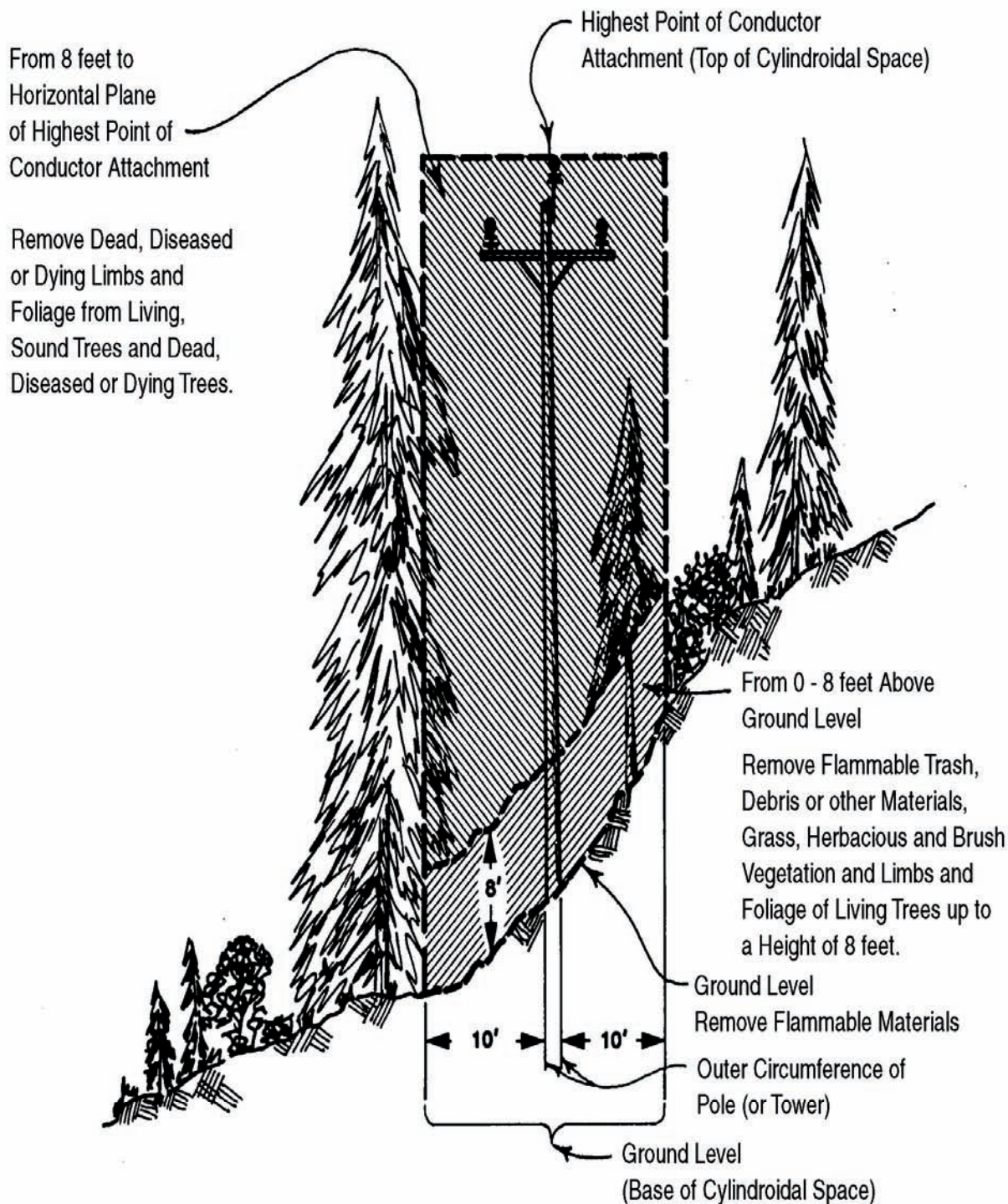

Figure 1-11
PRC 4293
14 CCR 1256
Conductor Clearance

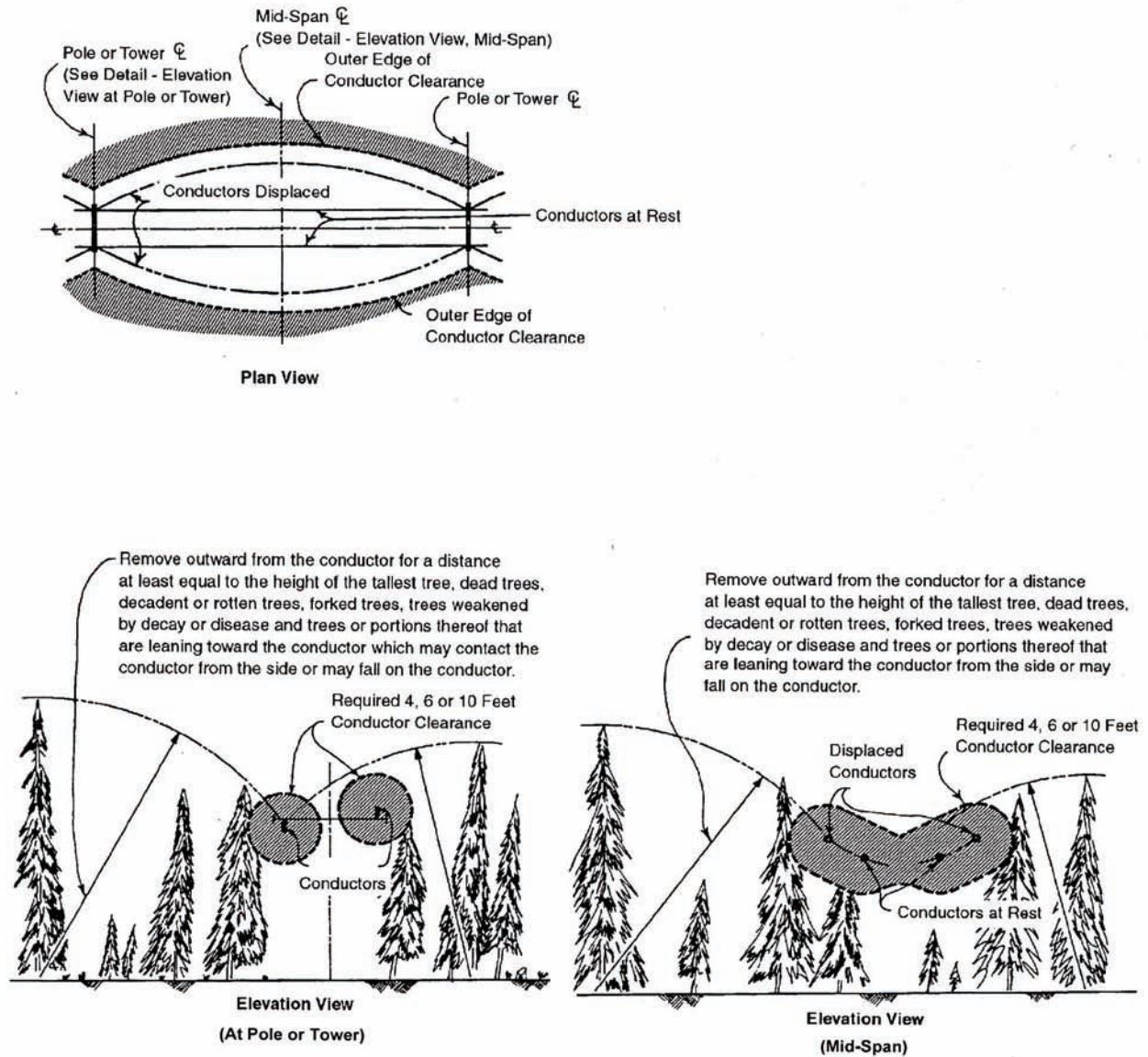
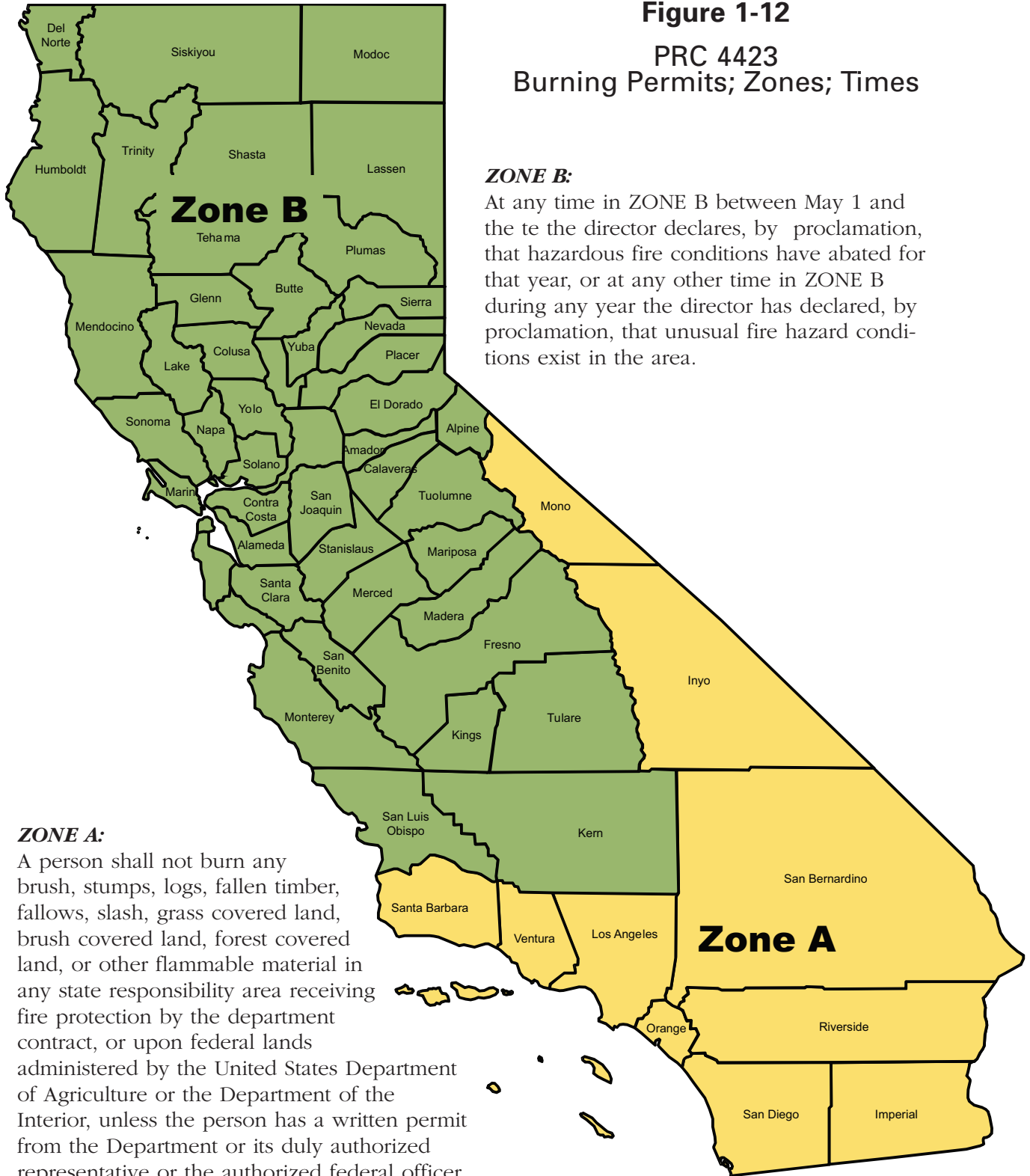

Figure 1-12
PRC 4423
Burning Permits; Zones; Times



ZONE B:

At any time in ZONE B between May 1 and the time the director declares, by proclamation, that hazardous fire conditions have abated for that year, or at any other time in ZONE B during any year the director has declared, by proclamation, that unusual fire hazard conditions exist in the area.

ZONE A:

A person shall not burn any brush, stumps, logs, fallen timber, fallows, slash, grass covered land, brush covered land, forest covered land, or other flammable material in any state responsibility area receiving fire protection by the department contract, or upon federal lands administered by the United States Department of Agriculture or the Department of the Interior, unless the person has a written permit from the Department or its duly authorized representative or the authorized federal officer on the federal lands administered by the United States Department of Agriculture or the Department of the Interior and in strict accordance with the terms of the permit at any time in ZONE A.

General Order No. 95, (Public Utilities Commission)

This is a book containing a great many specific rules intended primarily to ensure safe construction, maintenance, operation or use of overhead electrical lines. Utility personnel must be intimately familiar with it.

Protection agency personnel should be generally familiar with it since, although they have no responsibility for enforcing it, they can be of great help to the utilities by observing and reporting to the utilities infractions such as broken insulators or crossarms, deformed structures, sagging conductors, etc.

Code of Federal Regulations

Section 261 - Prohibitions

Section 261.10

Occupancy and Use

The following are prohibited:

- (a) Constructing, placing or maintaining any kind of road, trail, structure, fence, enclosure, communication equipment, or other improvement without a permit.

Section 261.50

Orders

- (a) The Chief, each Regional Forester, each Experiment Station Director, the Administrator of the Lake Tahoe Basin Management Unit and each Forest Supervisor may issue orders which close or restrict the use of described areas within the area over which he has jurisdiction. An order may close an area to entry or may restrict the use of an area by applying any or all of the prohibitions authorized in this subpart or any portion thereof.
- (b) The Chief, each Regional Forester, each Experiment Station Director, the Administrator of the Tahoe Basin Management Unit and each Forest Supervisor may issue orders which close or restrict the use of any forest development road or trail.
- (c) Each order shall:
 - (1) For orders issued under paragraph (a) describe the area to which the order applies;
 - (2) For orders issued under paragraph (b), describe the road or trail to which order applies;
 - (3) Specify the times during which the prohibitions apply if applied only during limited times;
 - (4) State each prohibition which is applied;
 - (5) Be posted in accordance with Section 261.51.
- (d) The prohibitions which are applied by an order are supplemental to the general prohibitions in Subpart A.
- (e) An order may exempt any of the following persons from any of the prohibitions contained in the order:
 - (1) Persons with a permit authorizing the otherwise prohibited act or omission. The issuing officer may include in any permit such conditions as he considers necessary for the protection or administration of the road, trail, or National Forest System or for the promotion of the health, safety, or welfare of its users.
 - (2) Owners or lessees of land in the area.
 - (3) Residents in the area.

- (4) Any Federal, State, or local officer, or member of an organized rescue or fire fighting force in the performance of an official duty.
- (5) Persons engaged in a business, trade or occupation in the area.
- (6) It is prohibited to violate the terms or conditions of a permit issued under (e) (1).
- (7) Any person wishing to use a Forest development road or trail or a portion of the National Forest System, should contact the Forest Supervisor, Director, Administrator or District Ranger to ascertain the special restrictions which may be applicable thereto.

Section 261.52

Fire

When provided by an order, the following are prohibited:

- (a) Building, maintaining, attending or using a fire, campfire or stove fire.
- (b) Using an explosive.
- (c) Smoking.
- (d) Smoking, except inside a building or vehicle, or while seated in an area at least three feet in diameter that is barren or cleared of all flammable materials.
- (e) Going into or being upon an area.
- (f) Possessing, discharging or using any kind of fireworks or other Pyrotechnic device.
- (g) Entering an area without any fire fighting tool prescribed by the order.
- (h) Operating an internal combustion engine except on a road.
- (i) Welding or operating acetylene or other torch with open flame.
- (j) Operating or using any internal or external combustion engine on any timber-, brush- or grass- covered land, including trails traversing such land, without a spark arrester, maintained in effective working order, meeting either (i) Department of Agriculture, Forest Service Standard 5100-1a; or (ii) the 80 percent efficiency level determined according to the appropriate Society of Automotive Engineers (SAE) recommended Practices J335 and J350.
- (k) Violating any state law specified in the order concerning burning, fires or which is for the purpose of preventing, or restricting the spread of fires.

Note: Under this subsection (261.52(k)) any or all of the state statutes and regulations quoted in Parts I and II of Appendix B, as well as other state laws, may be adopted as federal regulations.

Local Ordinances

Local agencies may have more restrictive regulations. Check with your local fire department.

Terms and Conditions of Permits and Easements

These vary so widely depending on date of issuance, location, issuing authority and type of use that no general statements regarding them are relevant. Some are quite restrictive while others are so loose as to be almost meaningless. Most lie somewhere between the two extremes but two are seldom alike. Employees of both utilities and fire agencies should obtain copies of the specific permits and easements pertaining to the power lines for which they are responsible and become thoroughly familiar with them. Copies or resumes of them should be inserted in this Guide.



Section 2 Non-Exempt

Clearance Required

Universal Fuse



Figure 2-1
Universal Fuse

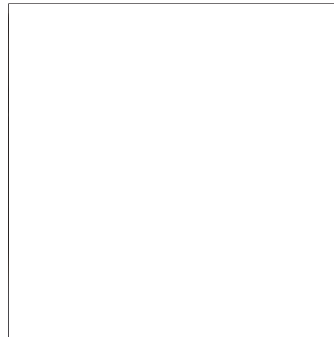

Round pull ring



Figure 2-2
**Universal Fuse, Fuse link,
Expulsion end of fuse**

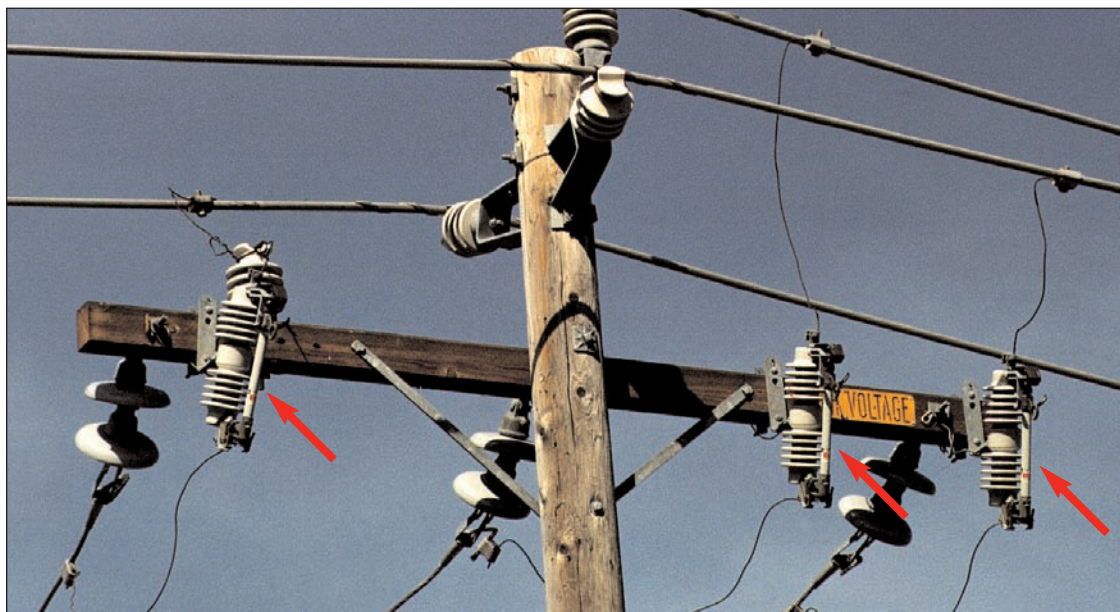

Figure 2-3
Arm Mounted Cutout with Universal Fuse

Open Link Fuse

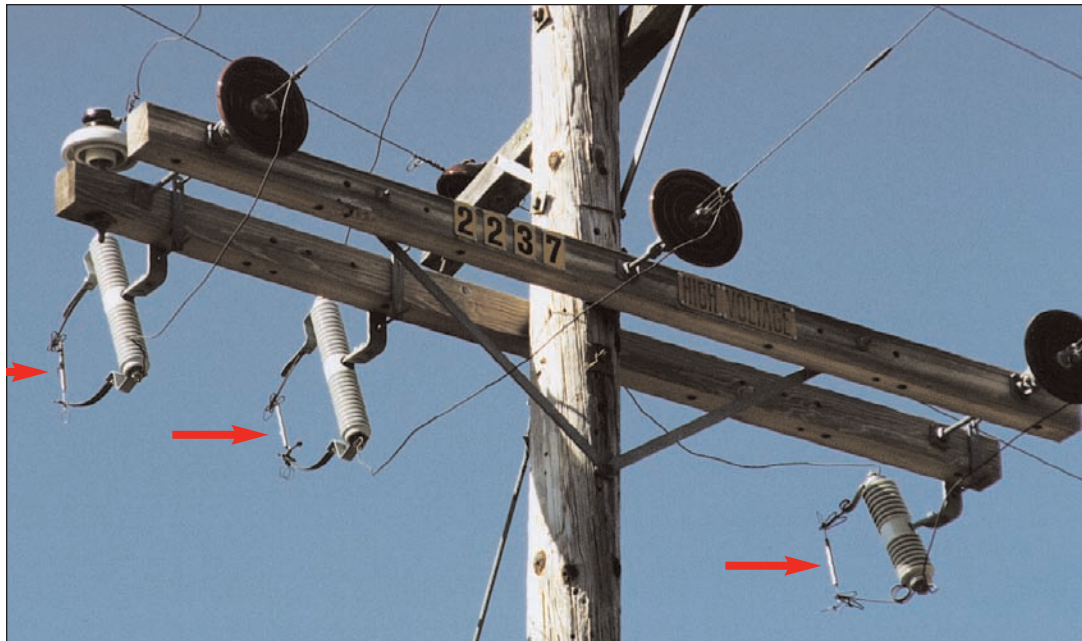

Figure 2-4
Arm Mounted Cutout with Open Link Fuse

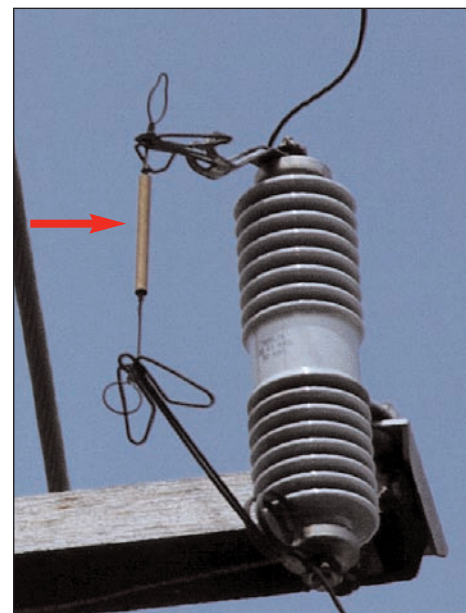

Figure 2-5
Open Link Fuse

Open Link Fuse

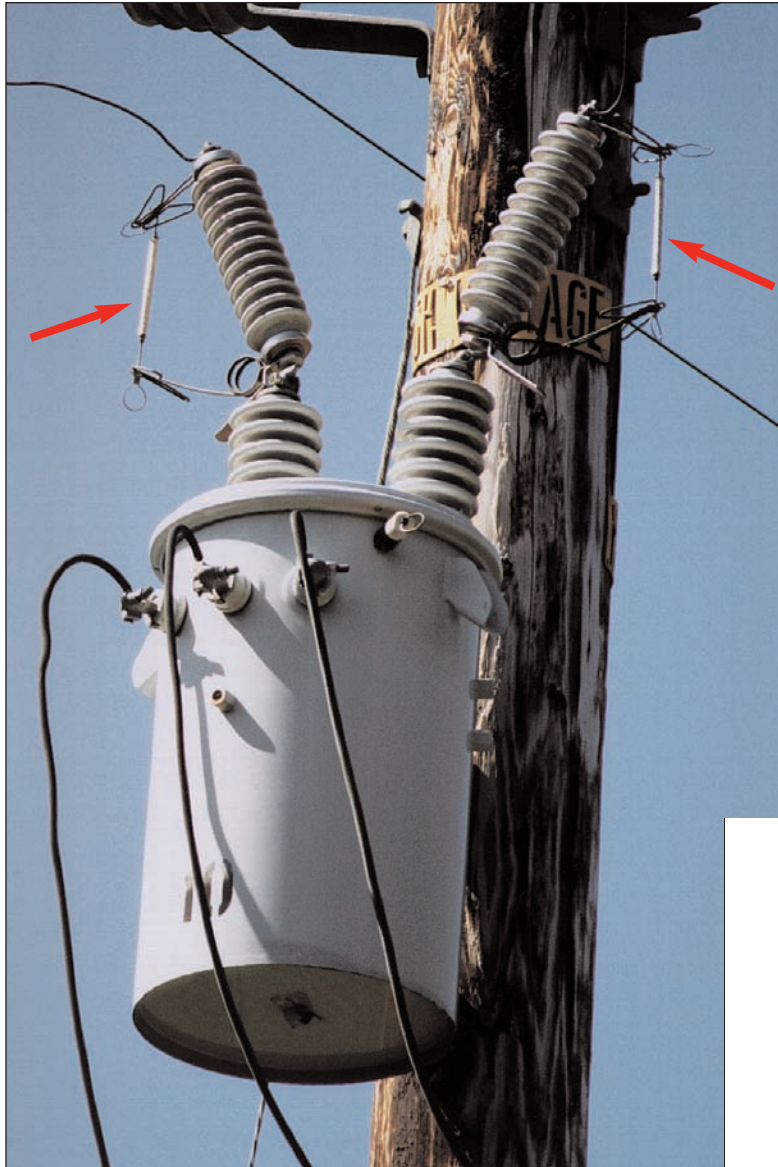

Figure 2-6
**Bushing Mounted Cutout
with Open Link Fuses**

Figure 2-7
Close up of Open Link Fuses

Enclosed Cutout w/ Universal Fuse



Figure 2-8
Enclosed Cutouts

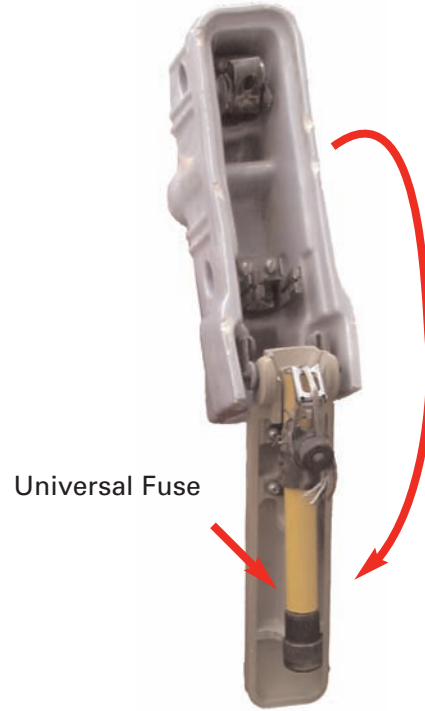

Figure 2-9
Open 4KV Cutout



Figure 2-10
Arm Mounted Enclosed Cutout with Universal Fuses

Solid Blade Disconnect

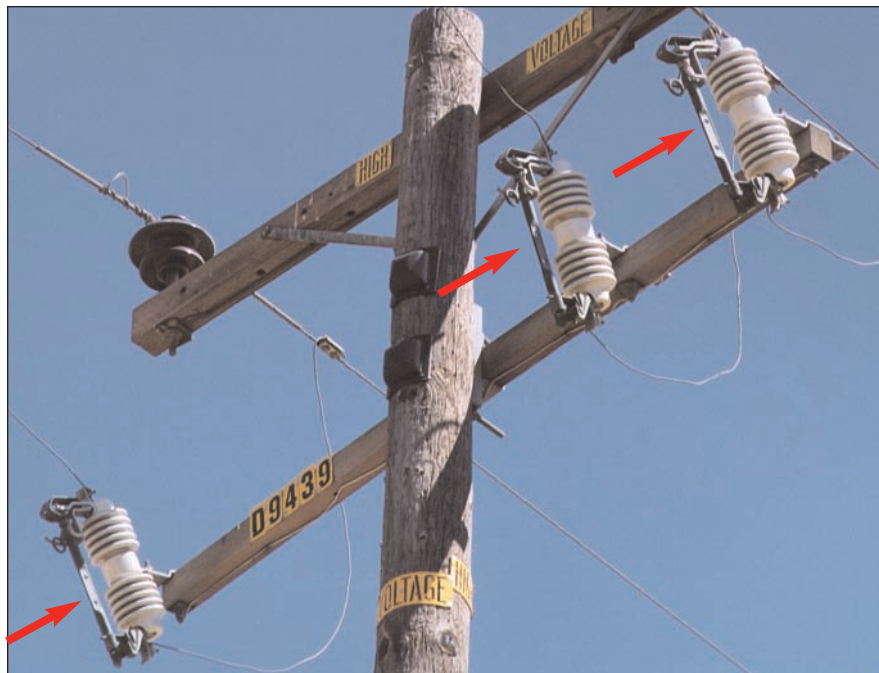

Figure 2-11
Arm Mounted Cutout with Solid Blade Disconnect (closed position)



Figure 2-12
Arm Mounted Cutout with Solid Blade Disconnect (open position)

Note: Solid Blade Disconnects are exempt under certain conditions. See pages 3-14, 3-15 and 3-16.

Solid Blade Disconnects

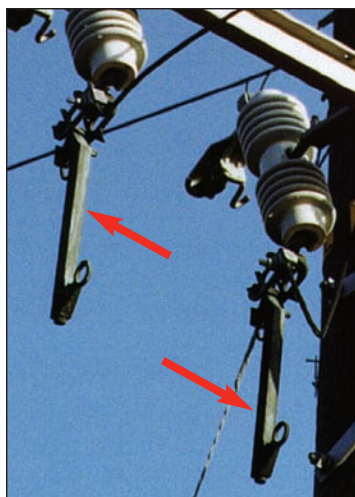
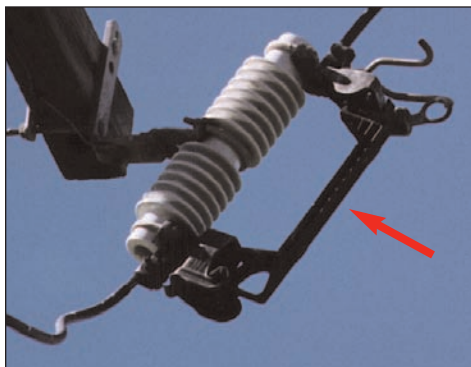
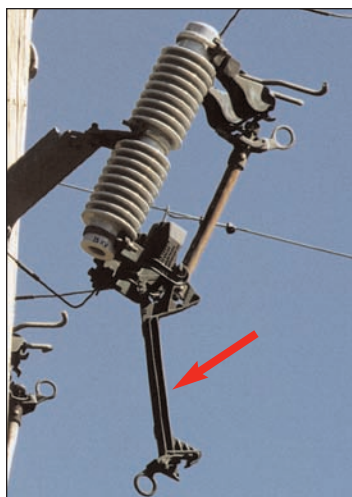

Figure 2-13
Solid Blade Disconnects



Note: Solid Blade Disconnects are exempt under certain conditions. See pages 3-14, 3-15 and 3-16

Solid Blade Disconnect

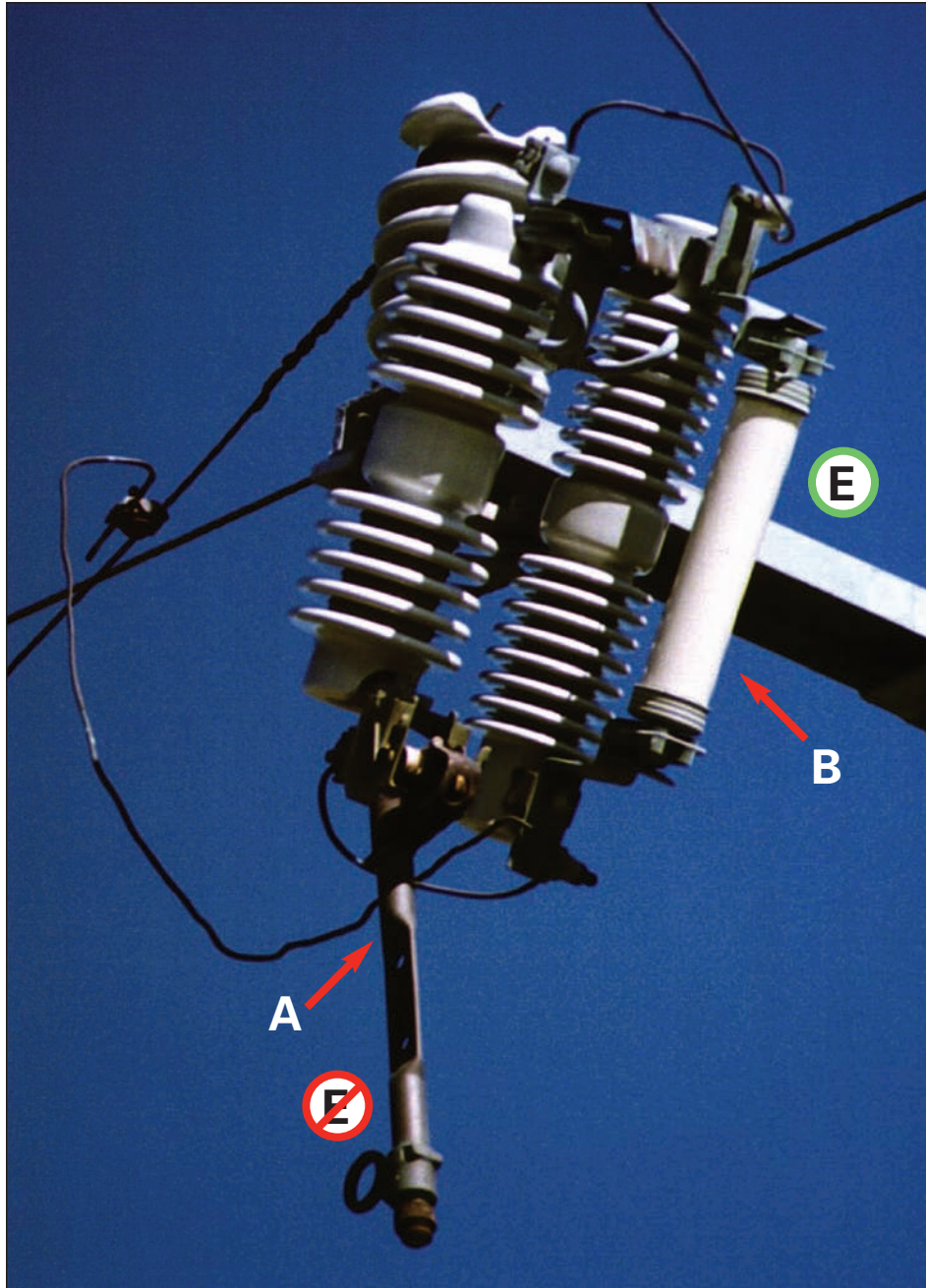



Figure 2-14

A. Solid Blade Bypass Disconnect in Open Position 

B. Arm Mounted Cutout with Non-Expulsion Fuse 

In-Line Disconnect

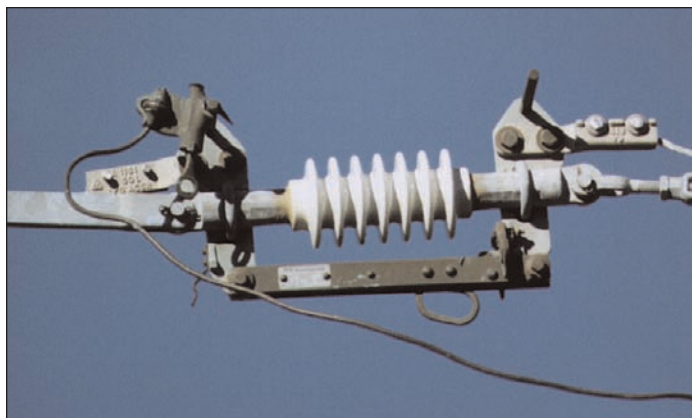

Figure 2-15
In-Line Disconnect (closed position)

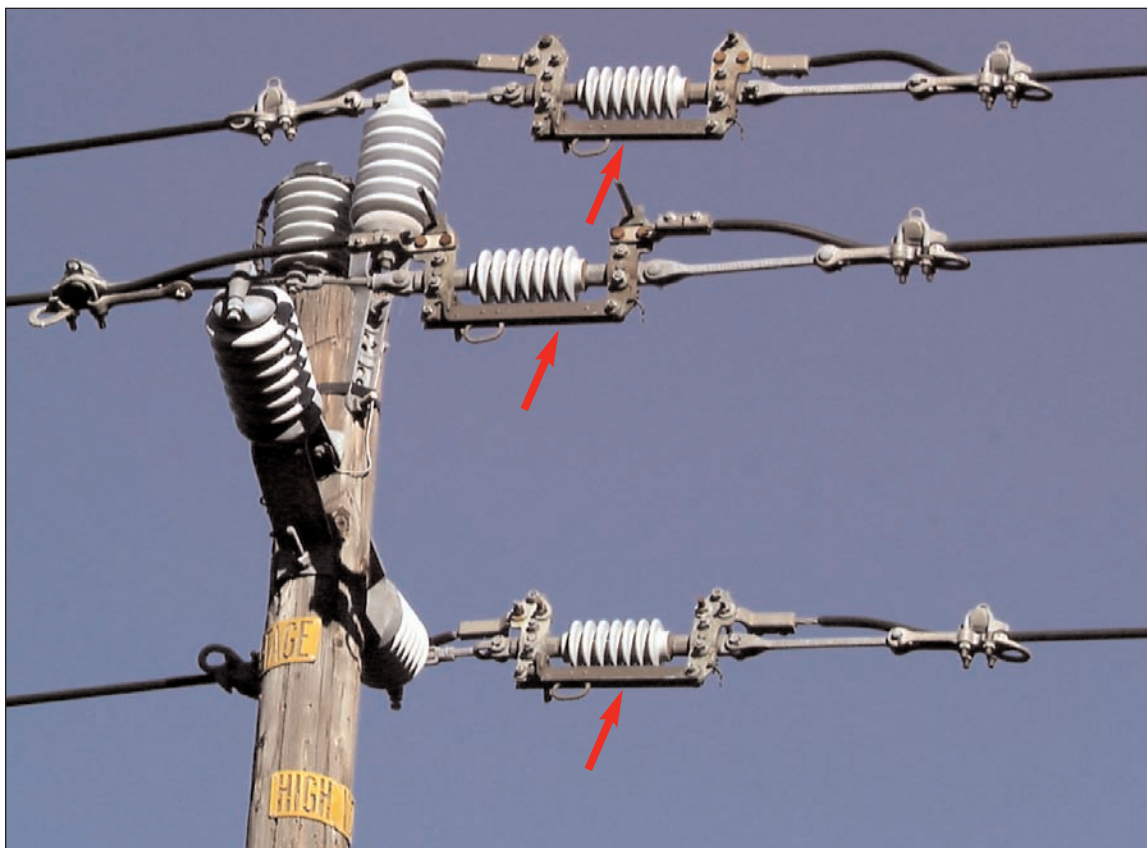

Figure 2-16
In-Line Disconnects (closed position)

Note: In-Line Disconnects are exempt under certain conditions. See pages 3-14, 3-15 and 3-16.

In-Line Disconnect

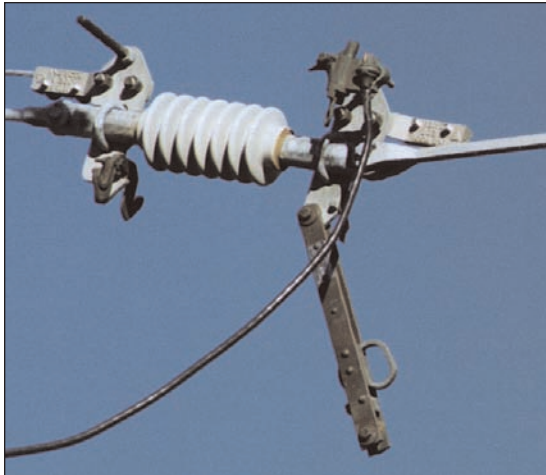

Figure 2-17
In-Line Disconnect (open position)

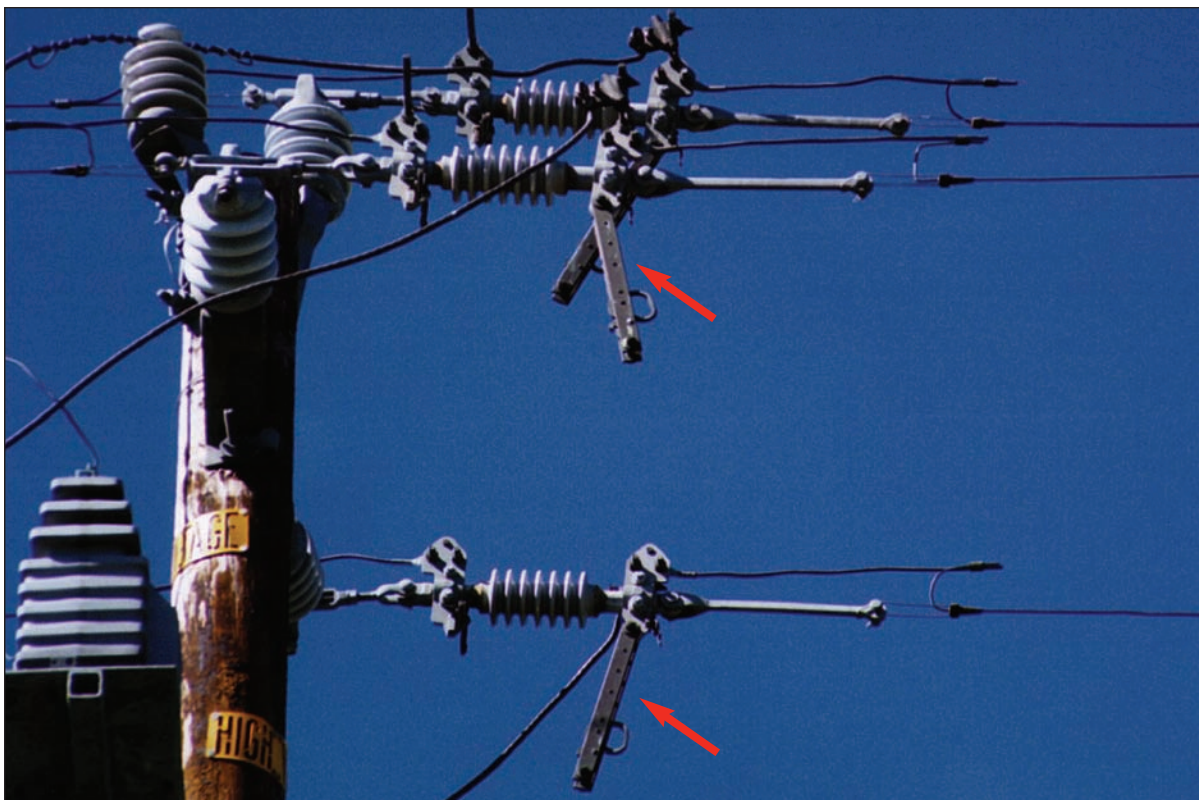

Figure 2-18
In-Line Disconnects (open position)

Note: In-Line Disconnects are exempt under certain conditions. See pages 3-14, 3-15 and 3-16.

Lightning Arrester

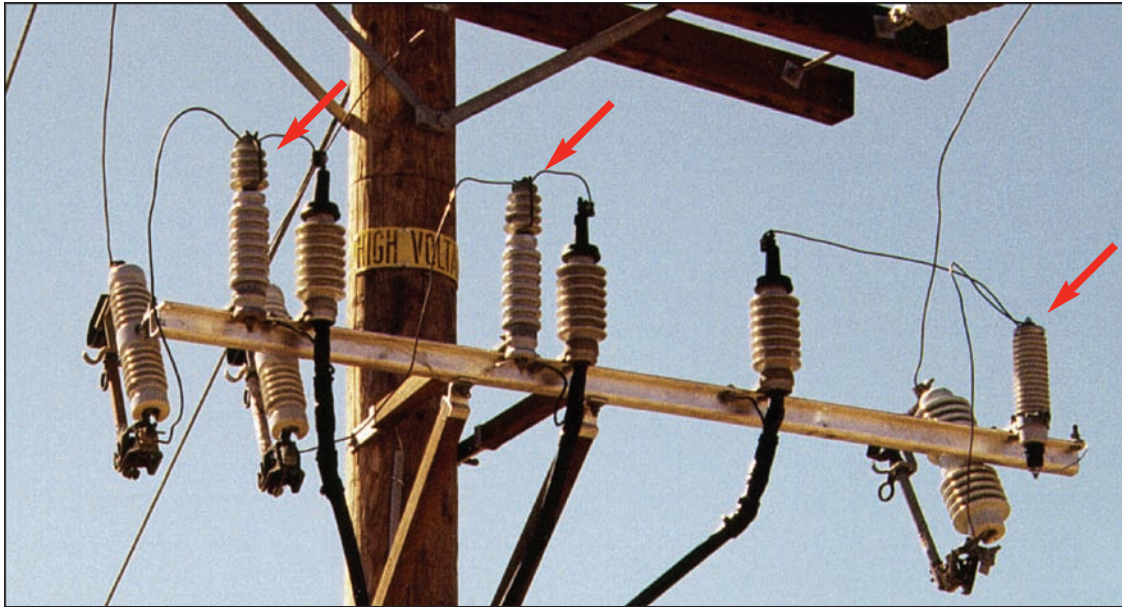

Figure 2-19
Arm Mounted Lightning Arrester (with Cable Riser and Universal Fuses)



Figure 2-20
Lightning Arrester (with Recloser)

Lightning Arrester

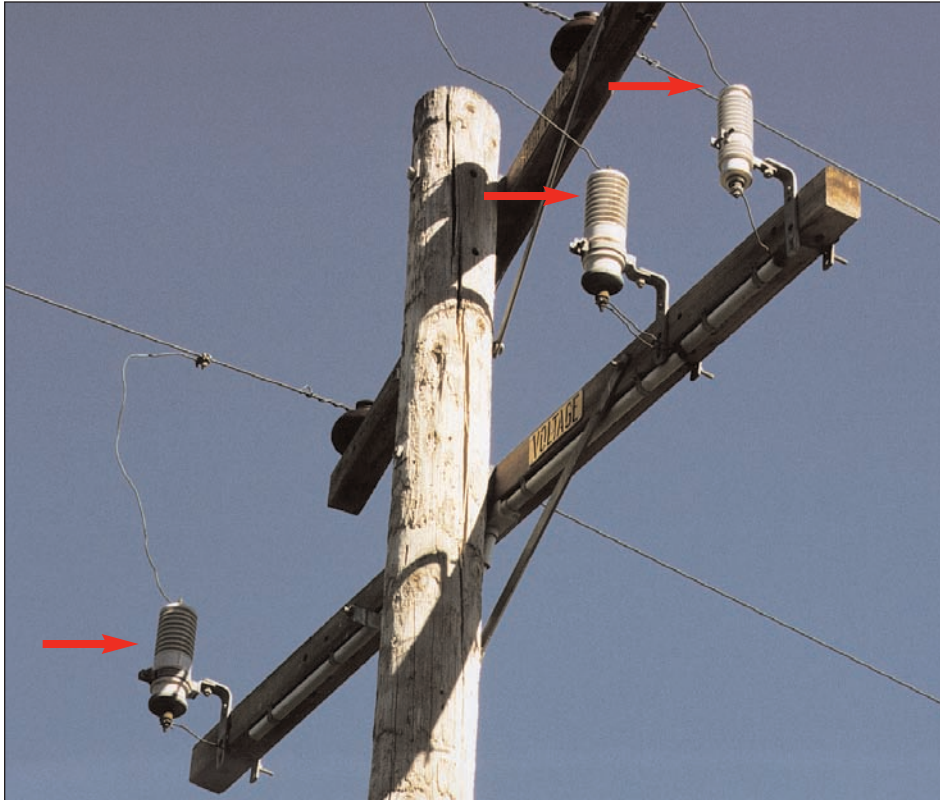

Figure 2-21
Lightning Arrester



Figure 2-22
Lightning Arrester

Non-Porcelain Lightning Arrester

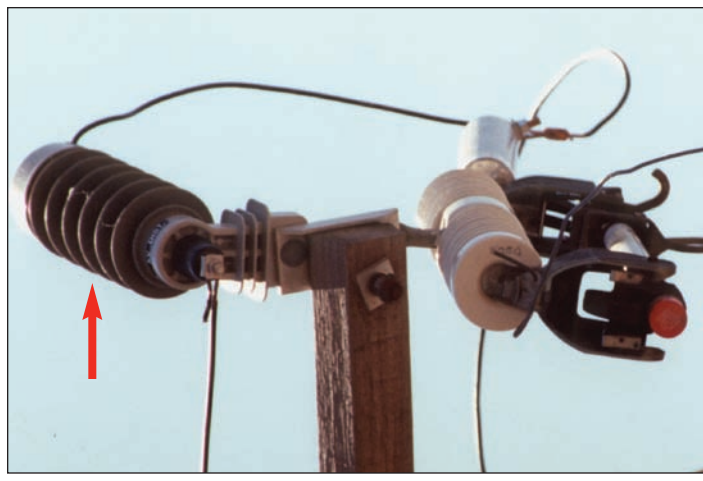

Figure 2-23
Non-Porcelain Lightning Arrester

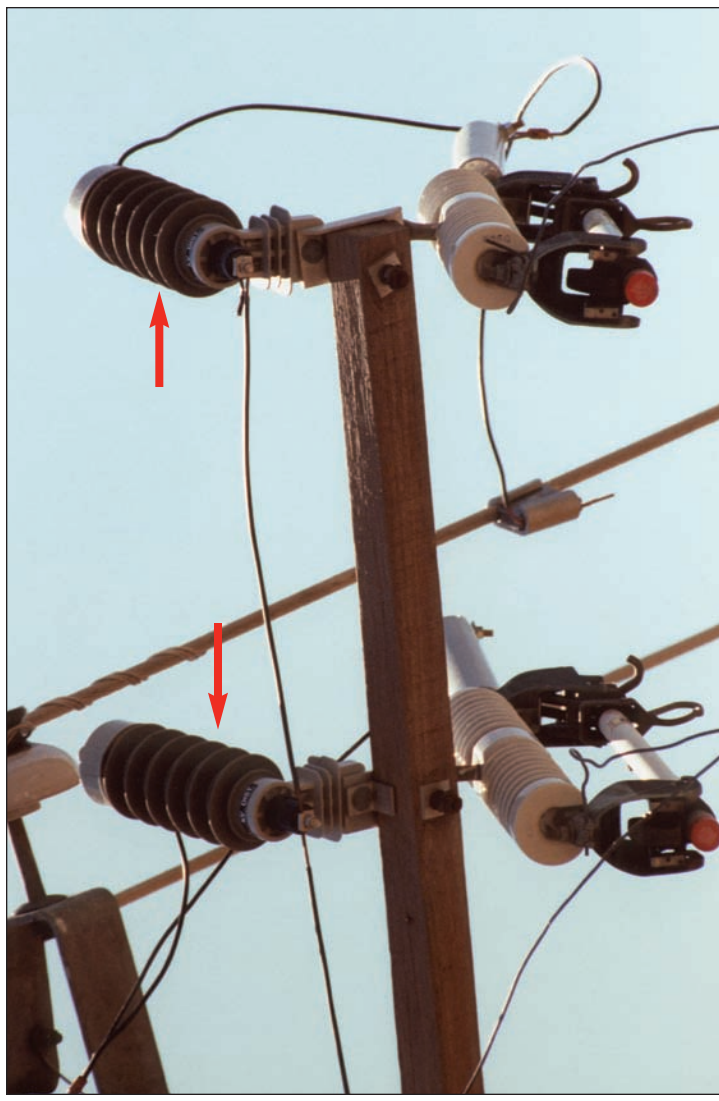

Figure 2-24
Non-Porcelain Lightning Arrester

Lightning Arrester

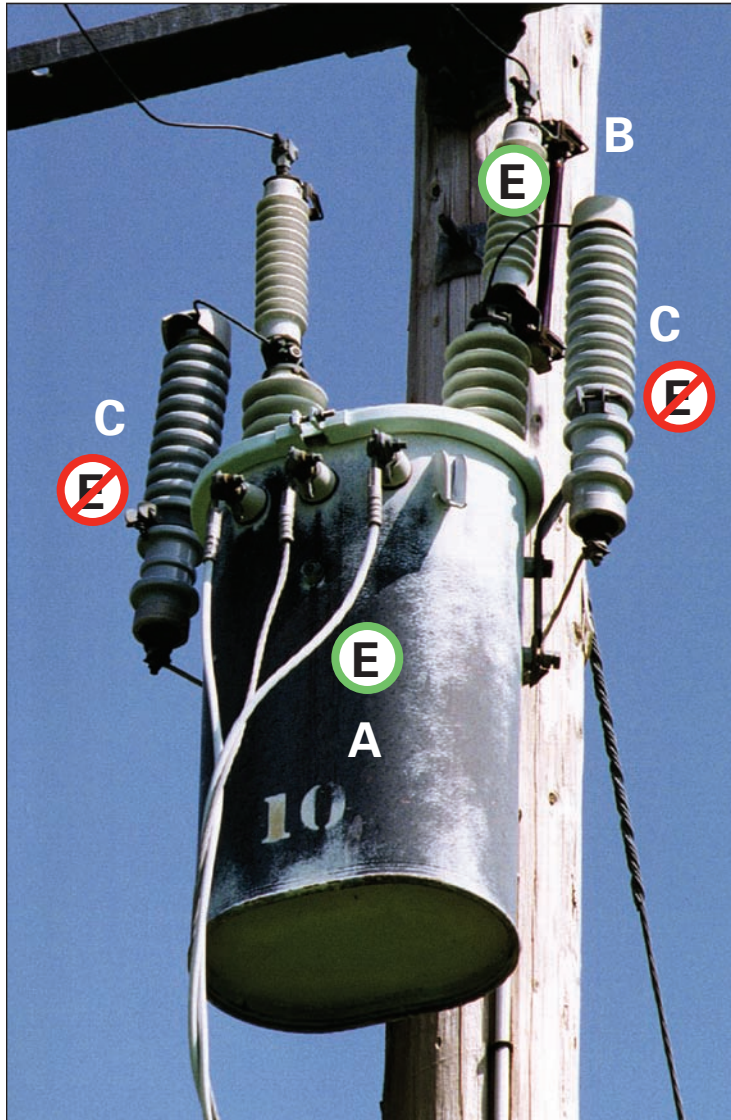



Figure 2-25
Transformer Mounted Lightning Arrester

- A. Conventional Transformer 
- B. Bushing Mounted Liquid Filled Fuse 
- C. Lightning Arresters 

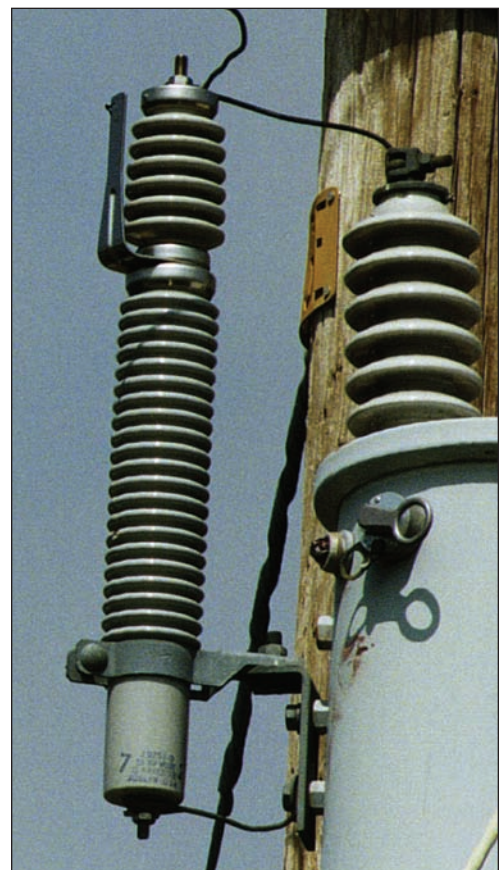

Figure 2-26
Gapped Lightning Arrester

Lightning Arrester

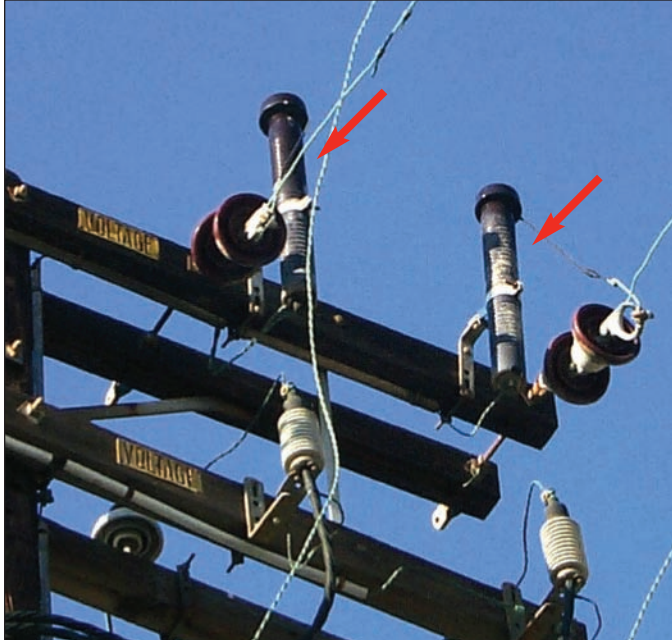

Figure 2-27
Lightning Arrester



Figure 2-28
Lightning Arrester

Hot Tap Clamp

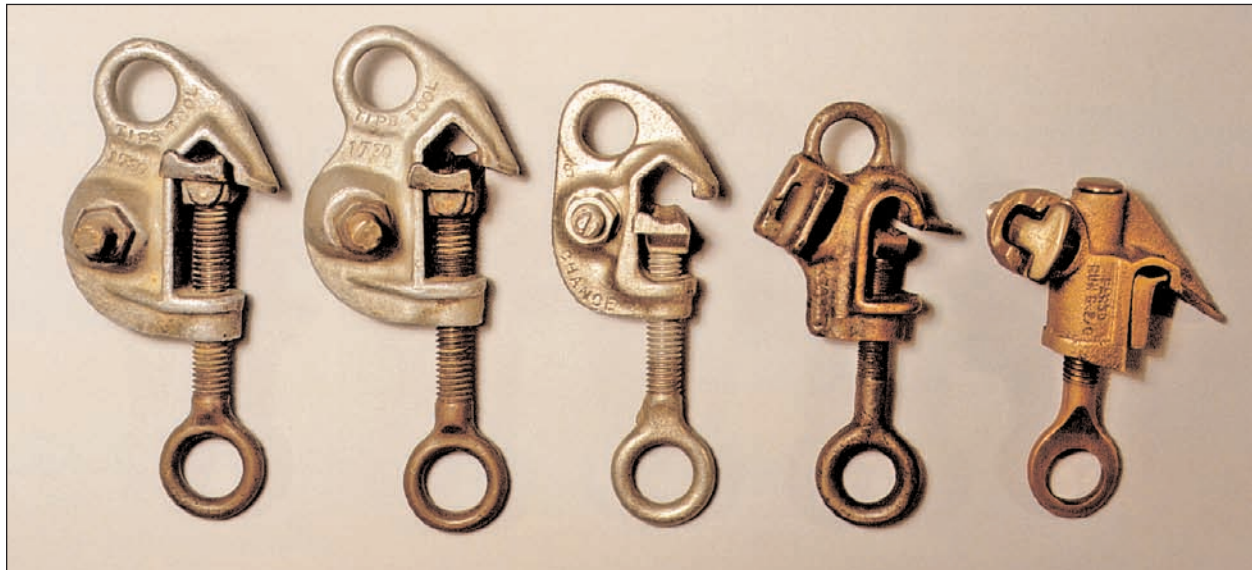

Figure 2-29
Hot Tap Clamps

Compare with exempt
hot tap clamps on page 3-21

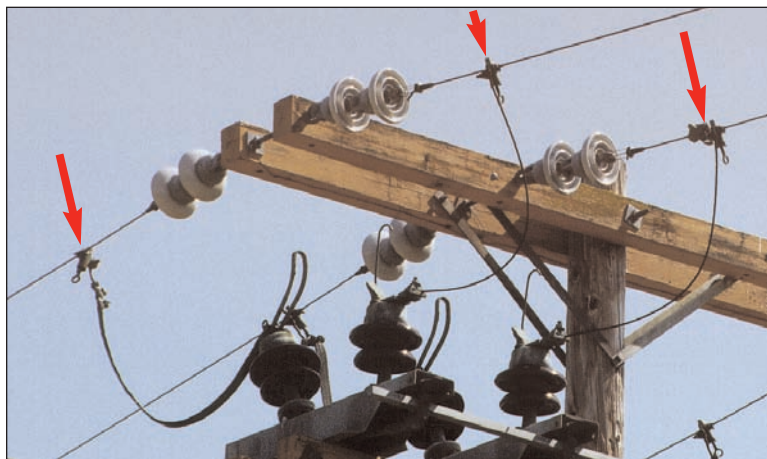

Figure 2-30
Hot Tap Clamps



Figure 2-31
Threads

Note: Some Hot Tap Clamps are exempt. See page 3-21.

Split Bolt Connector

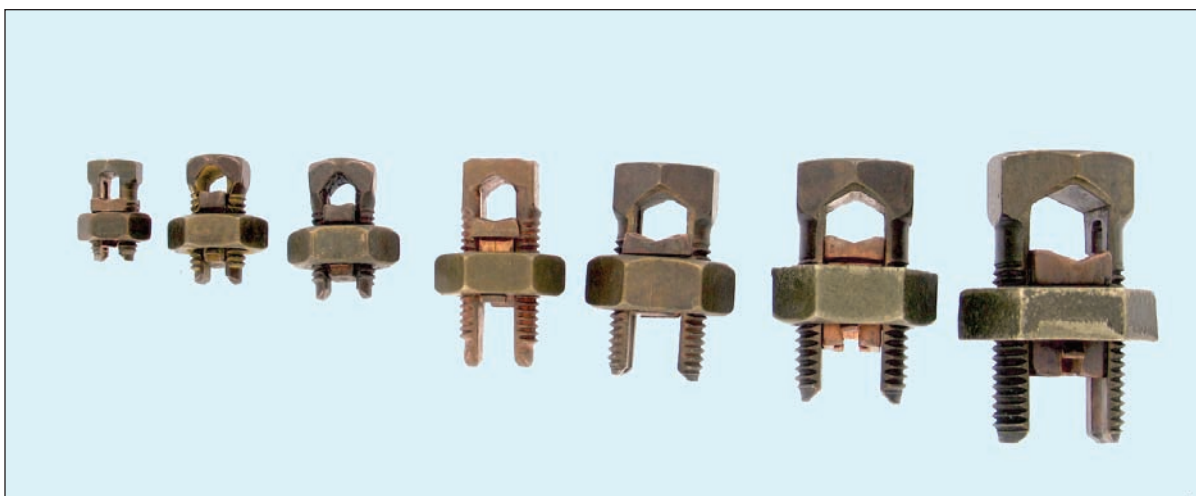

Figure 2-32
Split Bolt Connectors (various sizes)



Figure 2-33
Split Bolt Connector

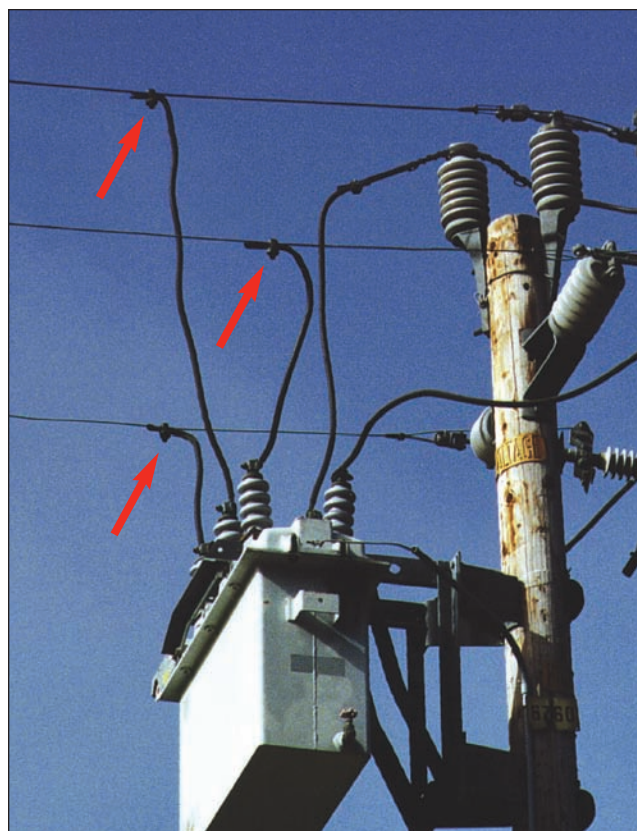

Figure 2-34
Split Bolt Connectors

Note: Some Split Bolt Connectors are exempt. See page 3-24.

Other Connectors

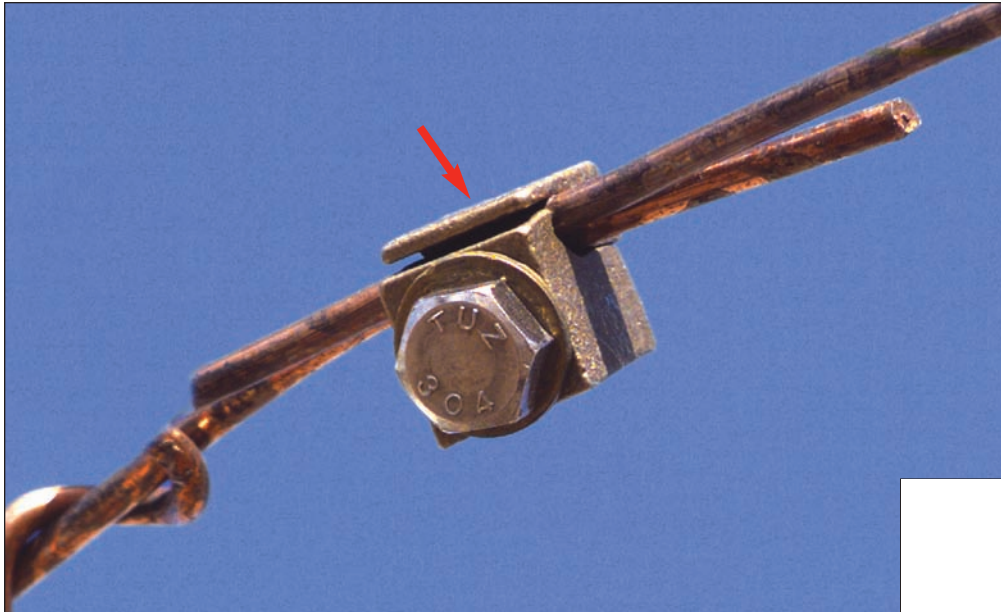

Figure 2-35
Fargo Connector

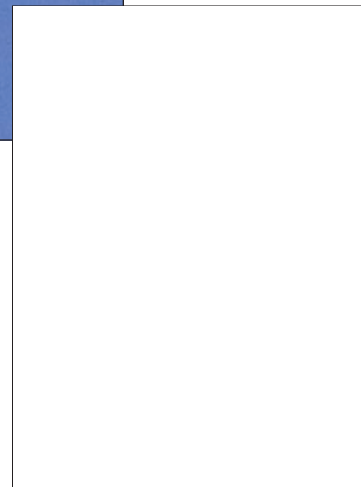

Figure 2-36
Fargo Connector

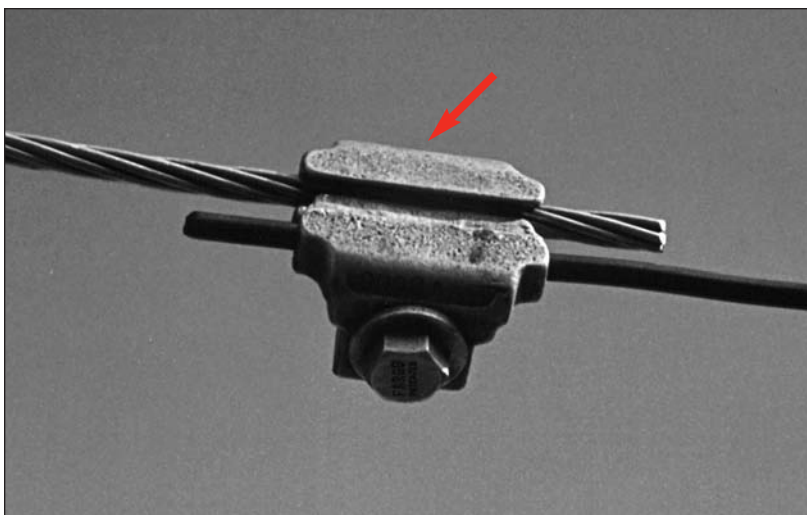

Figure 2-37
LM Connector

Grasshopper Air Switch

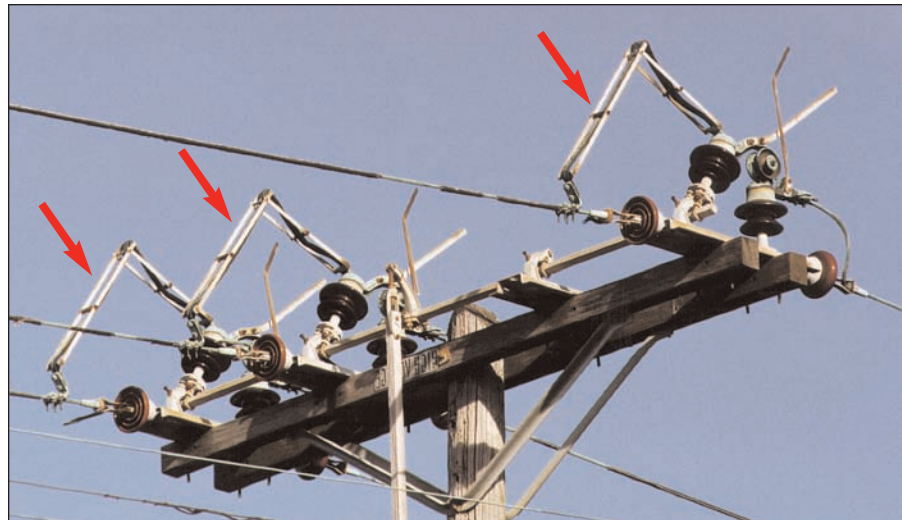

Figure 2-38
Grasshopper Air Switch (closed position)



Figure 2-39
Grasshopper Air Switch (open position)

Transmission Air Switch

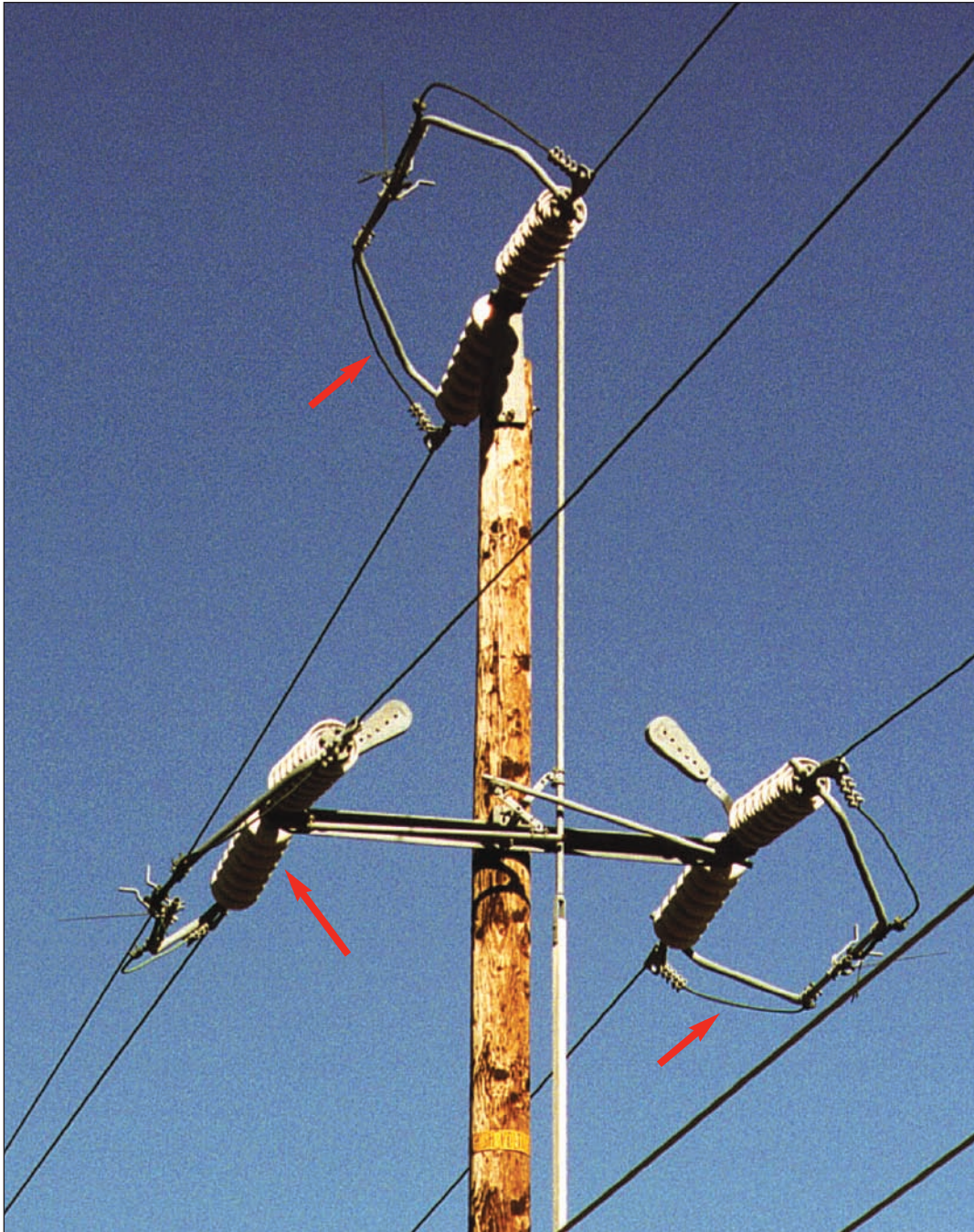

Figure 2-40
Transmission Air Switch, Pole Mounted 60kV (closed position)

Transmission Air Switch

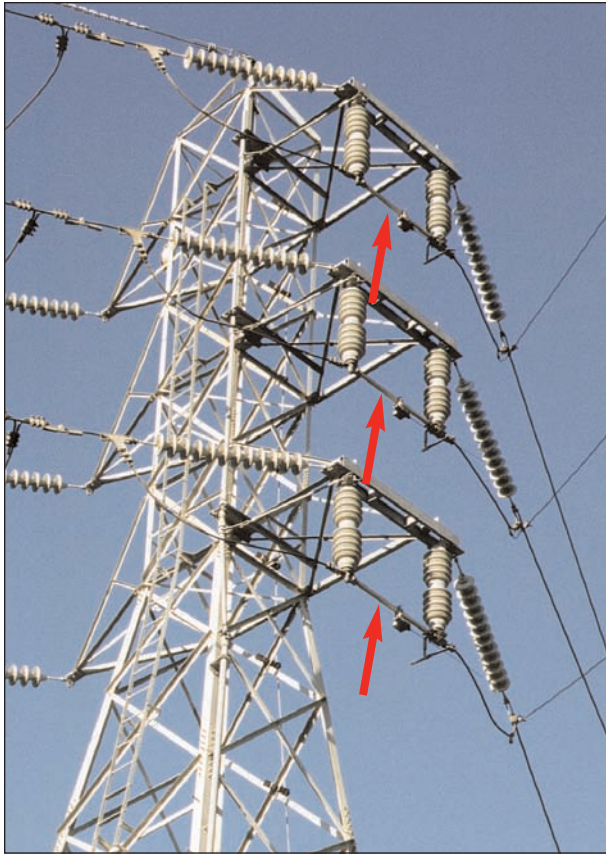

Figure 2-41
**Transmission Air Switches
Tower Mounted (closed position)**

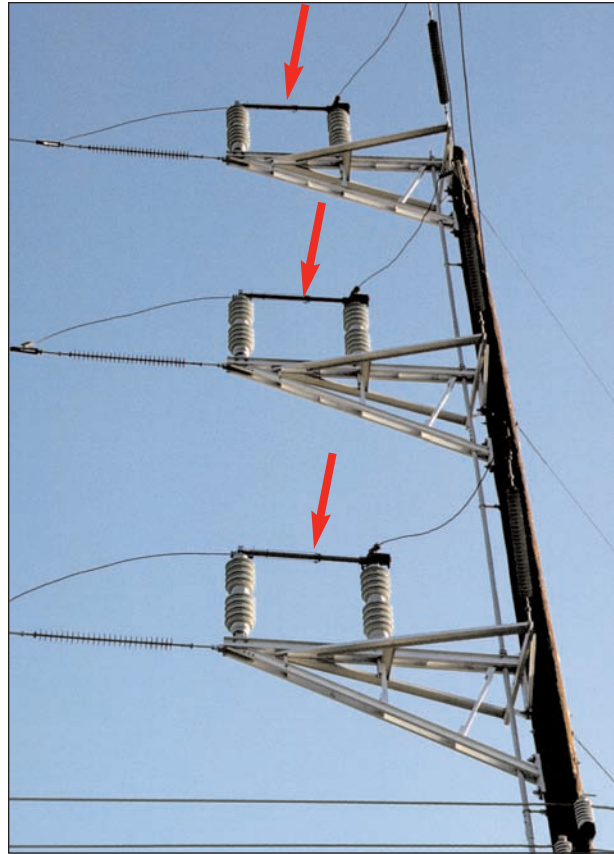

Figure 2-42
**Transmission Air Switches
Pole Mounted (closed position)**

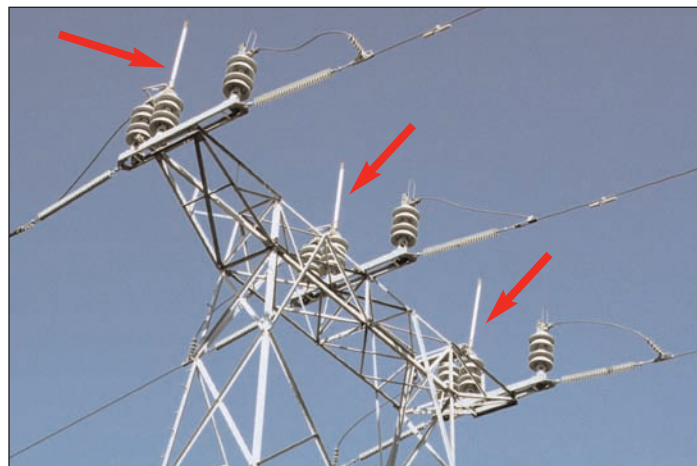

Figure 2-43
**Transmission Air Switches
Tower Mounted (open position)**



Section 3 Exempt

Clearance Not Required

Non-Expulsion Fuse

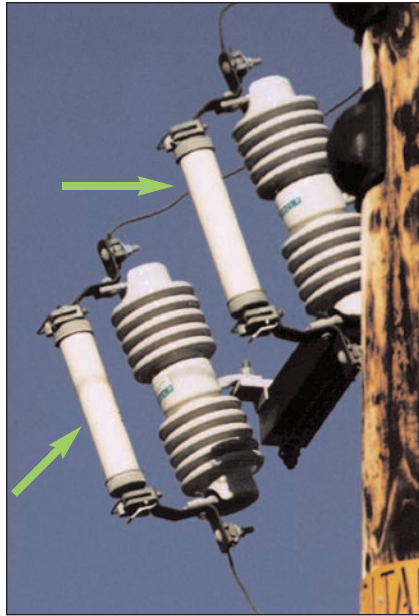

Figure 3-1
**Arm Mounted Cutout with
Non-Expulsion Fuse**

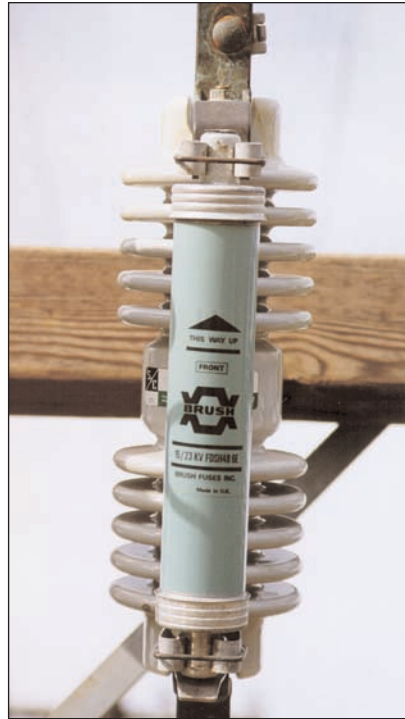

Figure 3-2
**Arm Mounted Cutout
with Non-Expulsion Fuse**



Figure 3-3
Arm Mounted Cutout with Non-Expulsion Fuses

Non-Expulsion Fuse



Figure 3-4
**Bushing Mounted Cutout with
Non-Expulsion Fuse**



Figure 3-5
**Bushing Mounted Cutout with
Non-Expulsion Fuses**

Energy Limiting Fuse



Figure 3-6
Also Fits "Open Link" Cutouts



Figure 3-7
Also Fits "Clip Style" Cutouts



Figure 3-8
Available in 11 1/2" and 8" sizes



Figure 3-9
Fault Indicator Cap
Indicator orange band
under blue cap

Liquid Filled Fuse



Figure 3-10
Arm Mounted Cutout with Liquid Filled Fuse



Figure 3-11
Liquid Filled Fuse

Liquid Filled Fuse

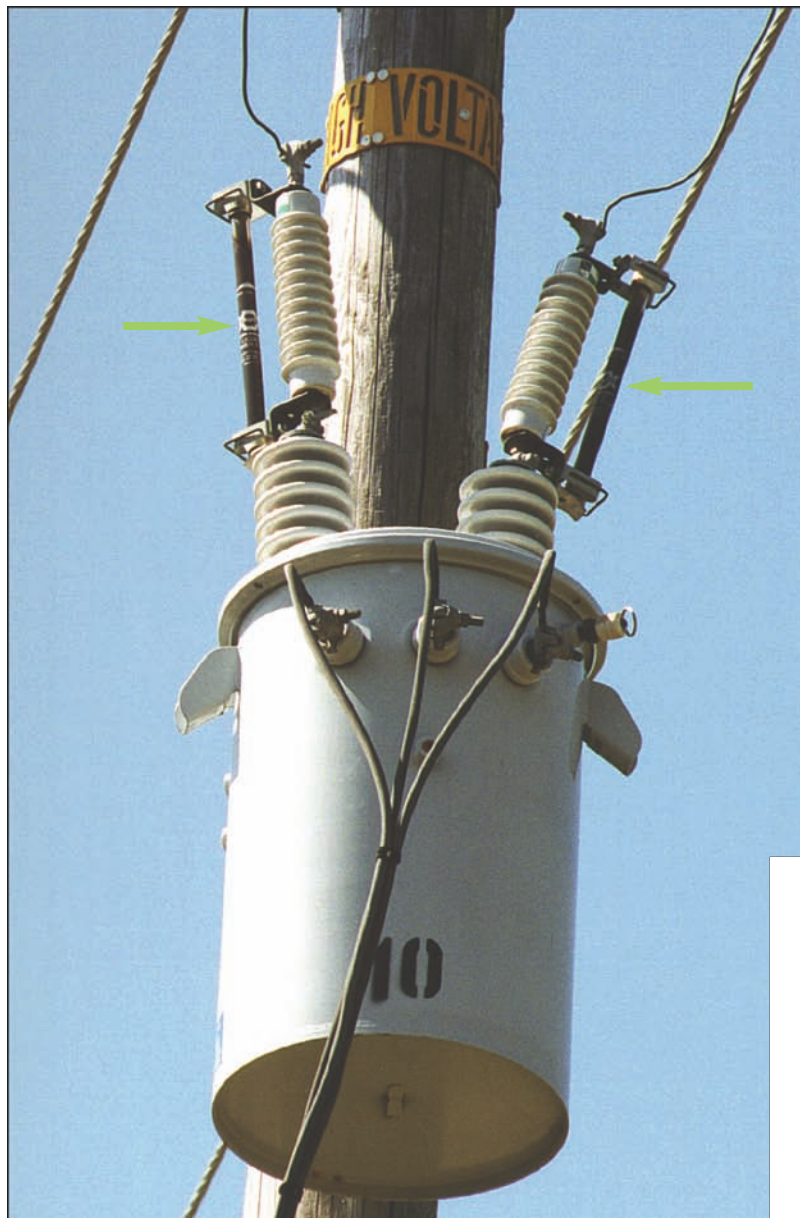

Figure 3-12
Over head Conventional Transformer with Bushing Mounted Cutout and Liquid Filled Fuse

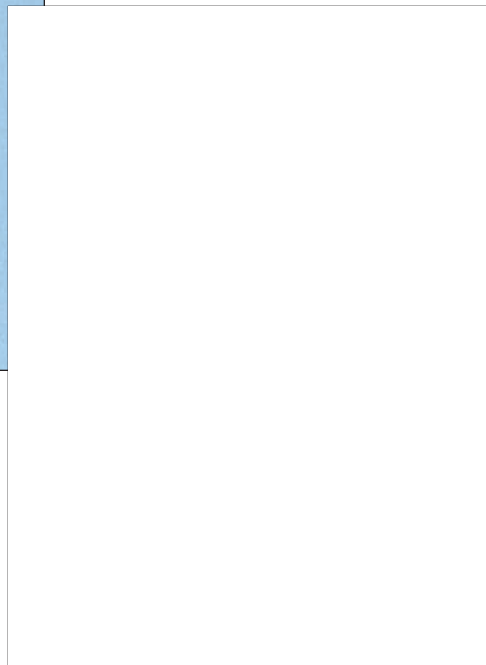

Figure 3-13
Liquid Filled Fuse

SMU-20 Fuse



Figure 3-14
Arm Mounted Cutout with SMU-20 Fuses



Figure 3-15
SMU-20 Fuse - Detail



Figure 3-16
Arm Mounted Cutout with SMU-20 Fuses

S&C Fault Tamer Fuse

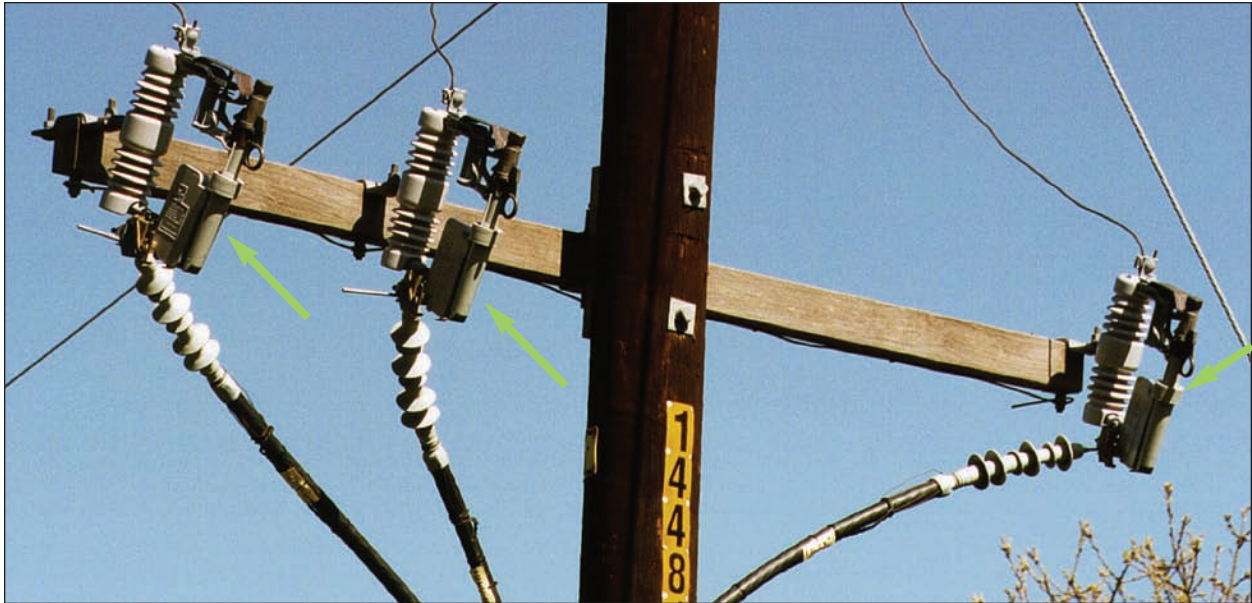

Figure 3-17
Arm Mounted Cutout with S&C Fault Tamer Fuse

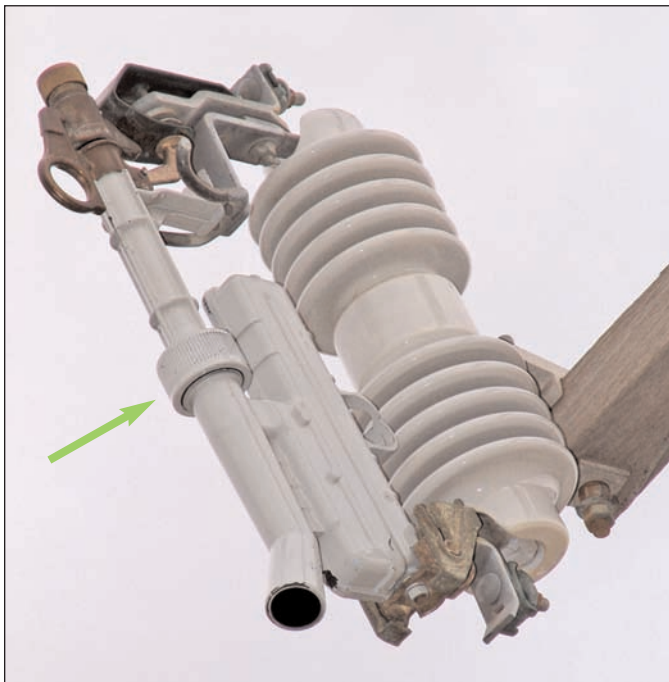

Figure 3-18
S&C Fault Tamer Fuse (Closed)



Figure 3-19
S&C Fault Tamer Fuse (Open)

600 Amp KPF Air Switch

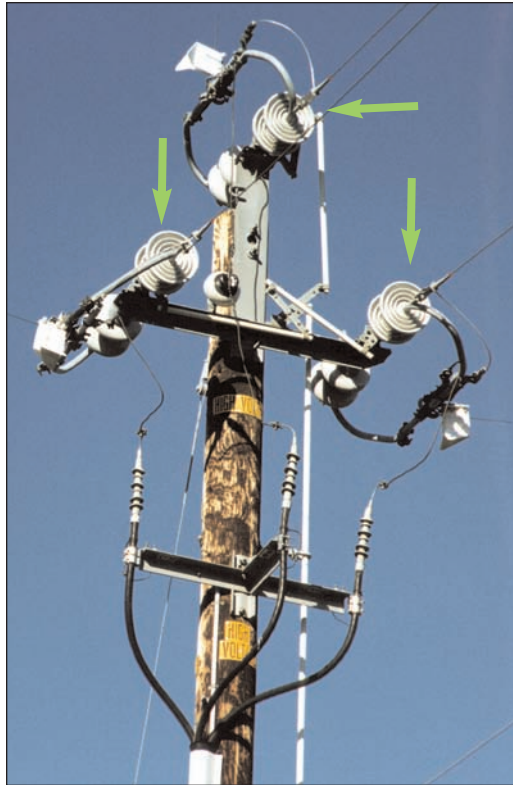

Figure 3-20
600 Amp KPF Air Switch, Triangular Construction (closed position)

Note: Exemption does not apply in SDG&E's Service Territory



A Sempra Energy utility®

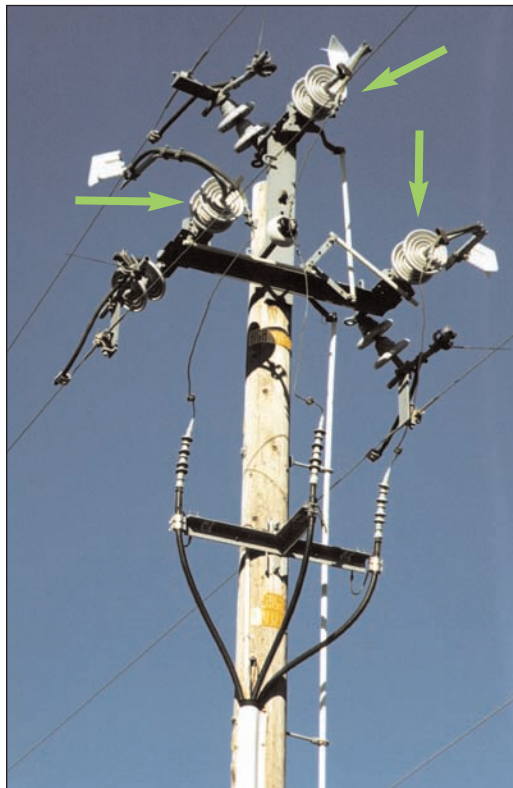

Figure 3-21
600 Amp KPF Air Switch, Triangular Construction (open position)

600 Amp KPF Air Switch



Figure 3-22
600 Amp KPF Air Switch, Crossarm Construction (closed position) with Arcing Horns and Snuffers

Note: Exemption does not apply in SDG&E's Service Territory





Figure 3-23
600 Amp KPF Air Switch, Crossarm Construction (closed position) without Arcing Horns or Snuffers

Underarm Sidebreak Switch



Figure 3-24
**600 Amp Underarm Sidebreak Switch
(open position)**

Figure 3-25
Open Unit

Figure 3-26
Closed Unit



Figure 3-27
600 Amp Underarm Sidebreak Switch (closed position)

S&C Underarm Side-Break Switch

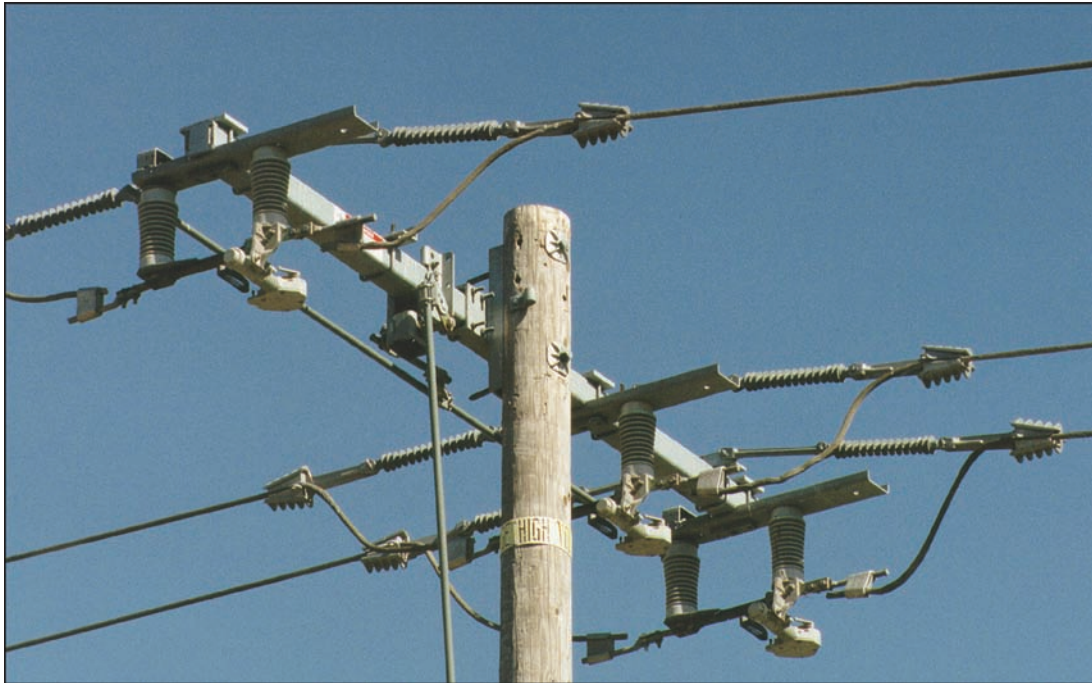

Figure 3-28
S&C 600 Amp Underarm Side-Break Switch (closed position)

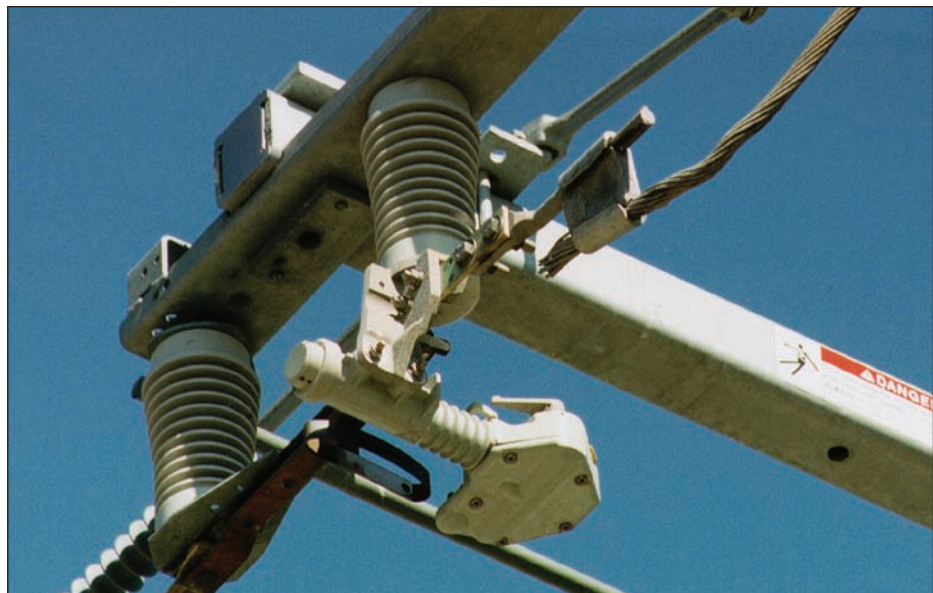

Figure 3-29
S&C 600 Amp Underarm Side-Break Switch (closed position)

S&C Omni-Ruptor Switch



Figure 3-30
S&C Omni-Ruptor Switch, Triangular Construction (open position)



Figure 3-31
S&C Omni-Ruptor Switch, Tangent Construction (closed position)

Figure 3-32
Closed Unit

Note: Upright version of Underarm Sidebreak Switch

S&C Scada-Mate Switch



Figure 3-33
S&C Scada-Mate Switch



Figure 3-34
Open Position
Indicator Green
Letter "O" visible



Figure 3-35
Closed Position
Indicator Red

Recloser

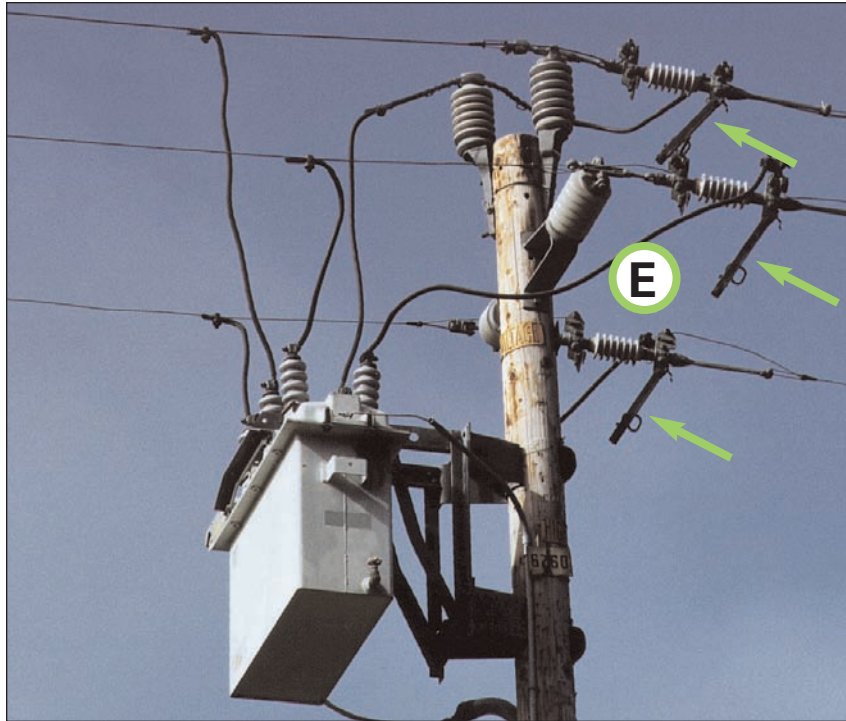

Figure 3-36
Recloser with In-Line Disconnects (open position)



Note: Only when used with Reclosers, Sectionalizers (page 3-15) or Voltage Regulators (page 3-16), In-Line Disconnects and Solid Blade Disconnects are exempt.



Figure 3-37
Recloser with Solid Blade Disconnects (closed position)

Sectionalizer

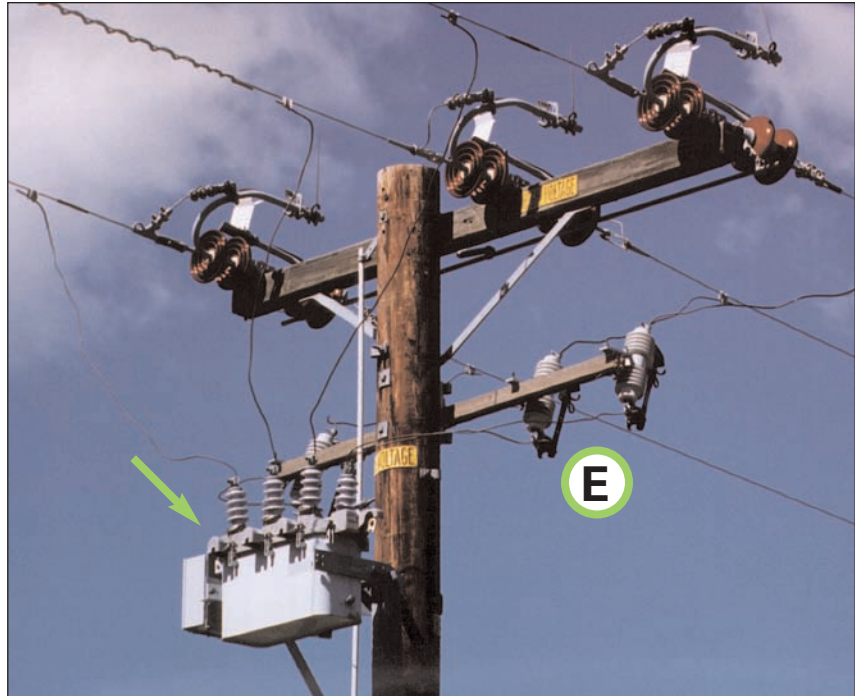

Figure 3-38
Sectionalizer with Solid Blade Disconnects



Note: Only when used with Sectionalizers, Reclosers (page 3-14) or Voltage Regulators (page 3-16), In-Line Disconnects and Solid Blade Disconnects are exempt.



Figure 3-39
Sectionalizer

Voltage Regulator

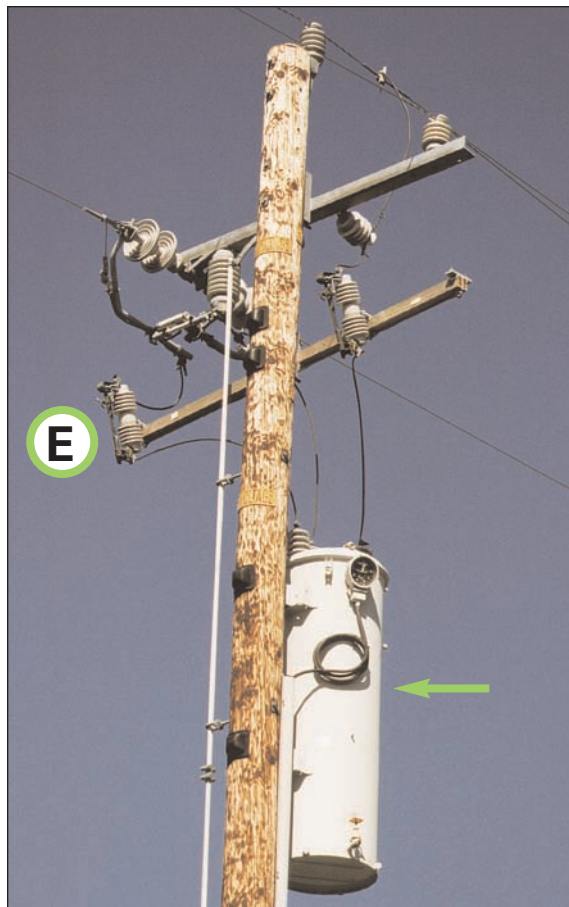

Note: Only when used with Reclosers, (page 3-14) Sectionalizers, (page 3-15), or Voltage Regulators, In-Line Disconnects and Solid Blade Disconnects are exempt

Figure 3-40
Voltage Regulator with Solid Blade Disconnects



Figure 3-41
Voltage Regulator

Capacitor Bank



Figure 3-42
Capacitor Bank



Figure 3-43
Capacitor Unit

Transformer

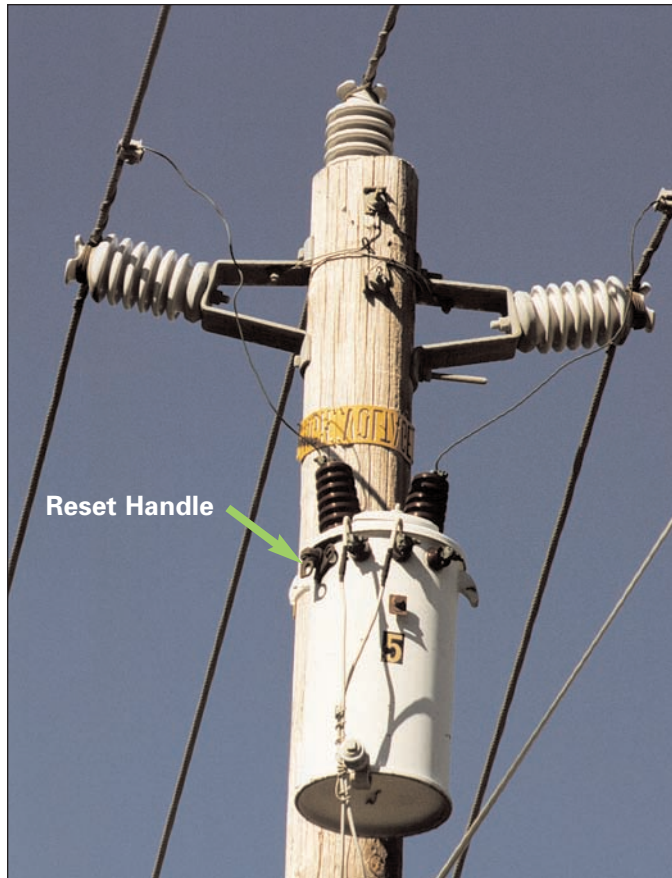

Figure 3-44
**Self-Protected Transformer
(no external cutouts or fuses)**

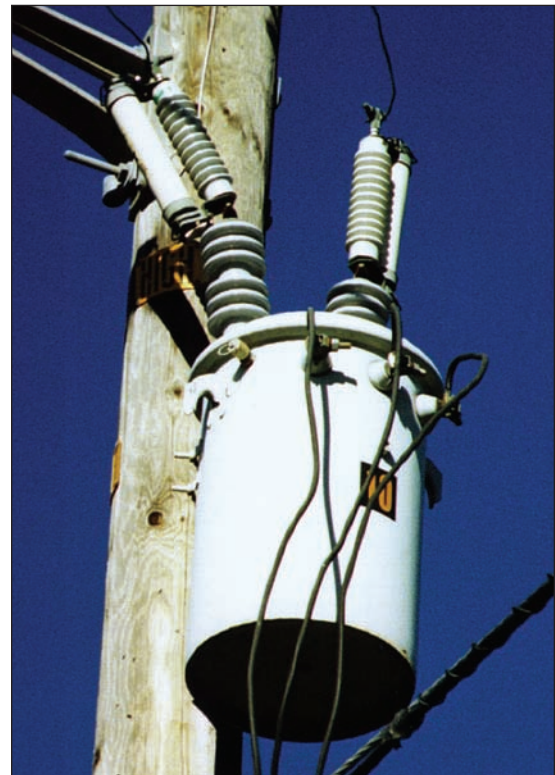

Figure 3-45
**Conventional Transformer
with Exempt Fuses**

Parallel Groove Connectors



Figure3-46
Parallel Groove Connectors

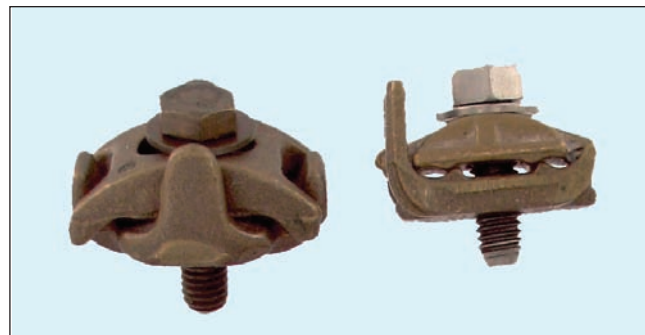

Figure 3-47
Copper Parallel Groove Connectors



Figure3-48
Parallel Groove Connectors on Jumpers

Parallel Groove Connectors

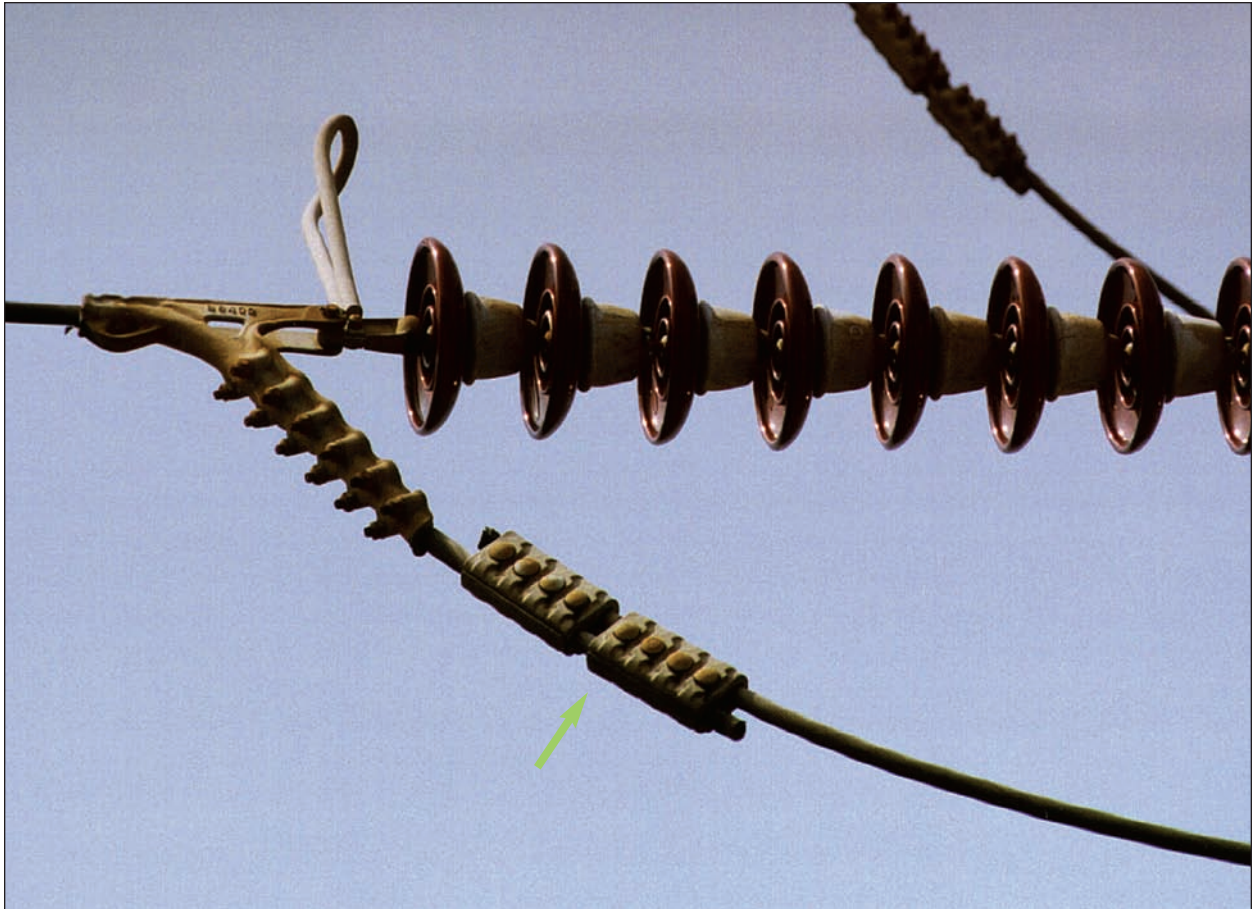

Figure 3-49
Transmission Deadend with Parallel Groove Connectors

Hot Tap Clamp

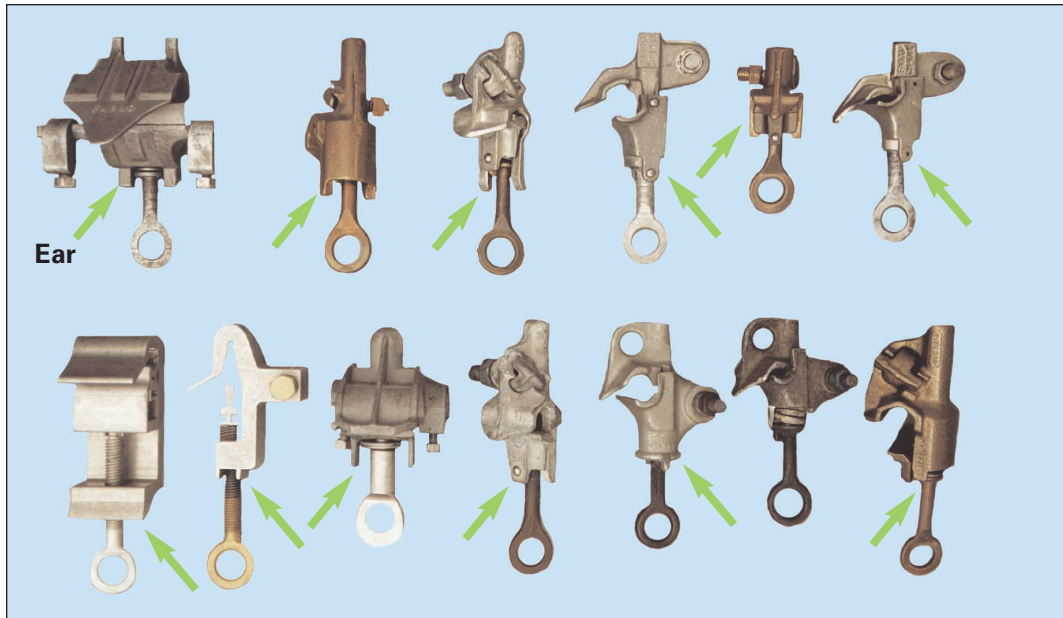

Figure 3-50
Hot Tap Clamps



Figure 3-51
Compare with non-exempt
hot tap clamps on page 2-15

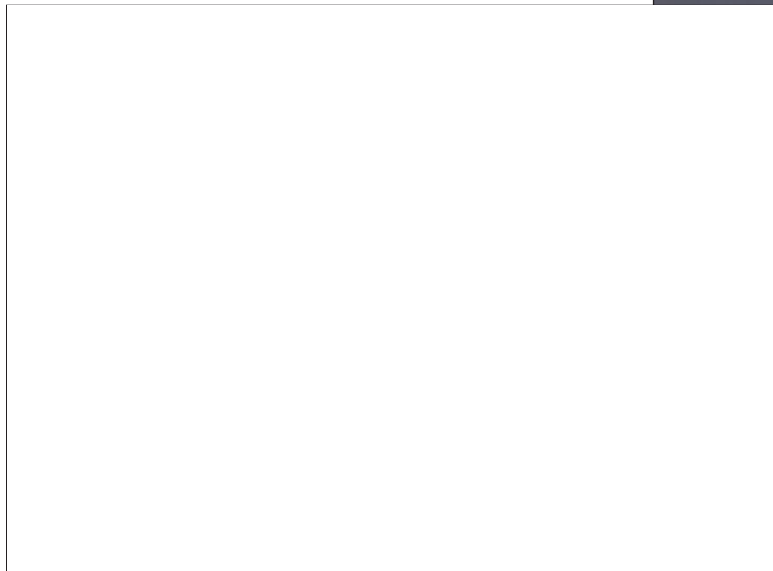

Figure 3-52
Hot Tap Clamps on Line

Note: Some Hot Tap Clamps are non-exempt. See page 2-15

Piercing Tap Clamp

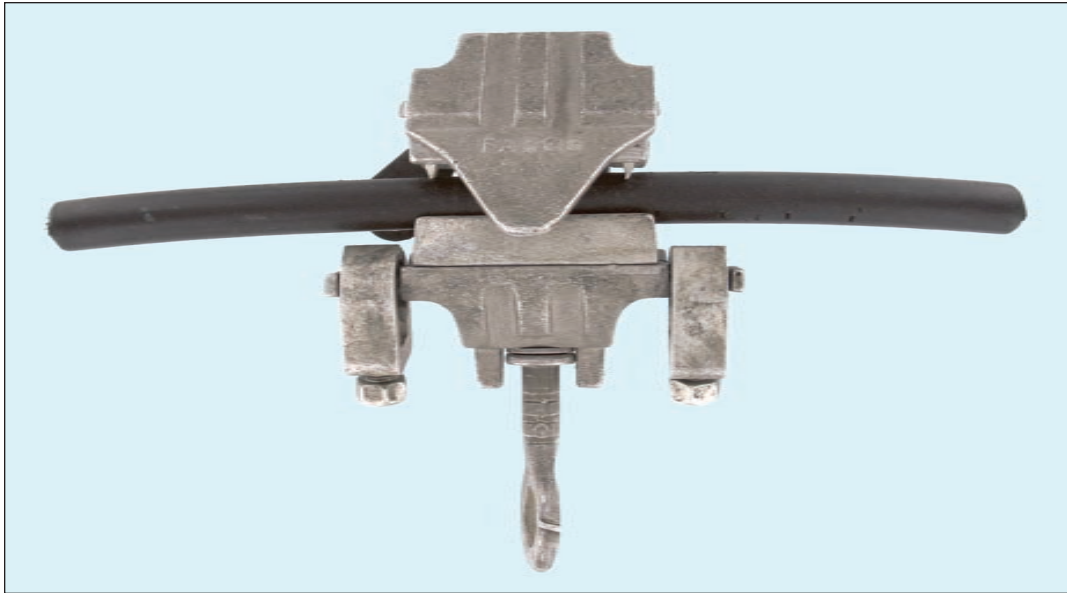

Figure 3-53
Piercing Hot Tap Clamp on Tree Wire

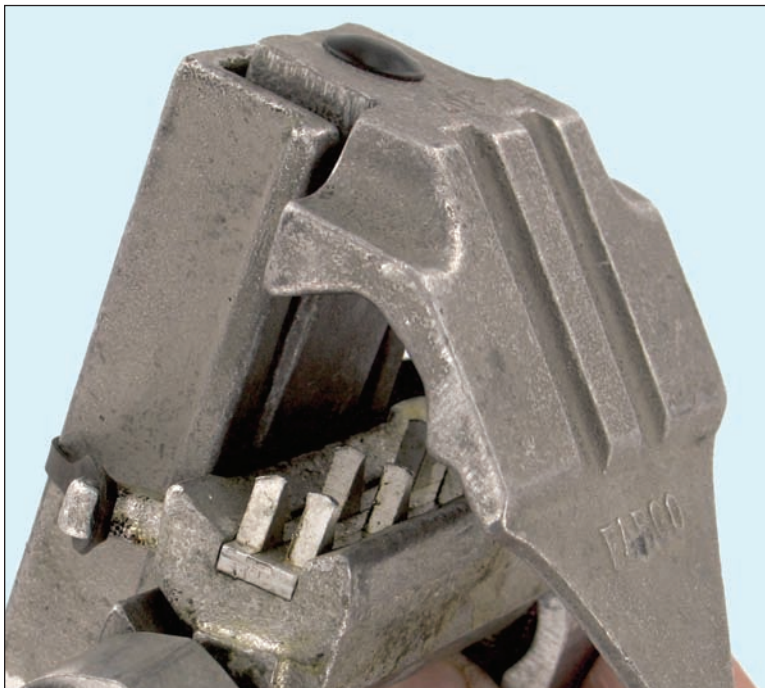

Figure 3-54
Piercing Hot Tap Clamp - Detail

Tree Wire

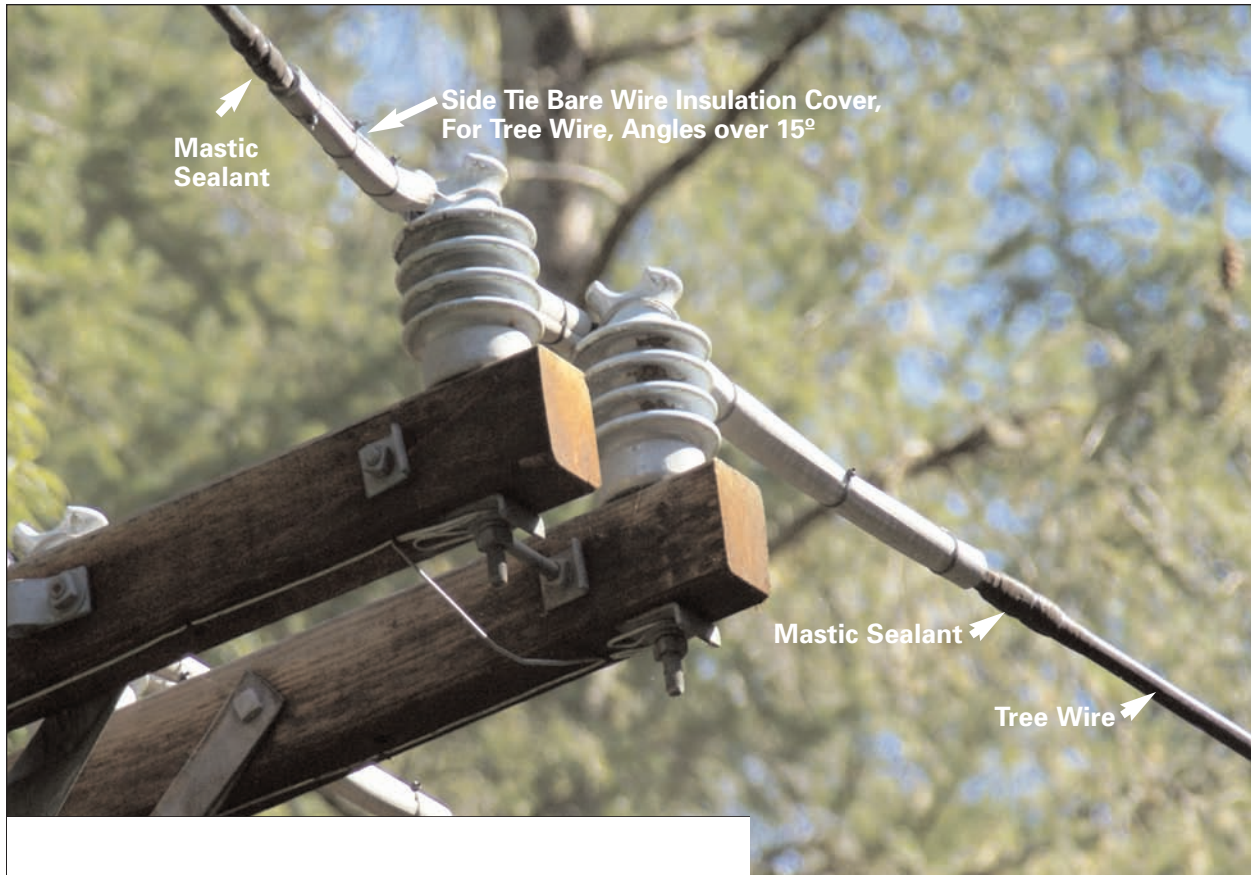

Figure 3-55
Tree Wire Detail

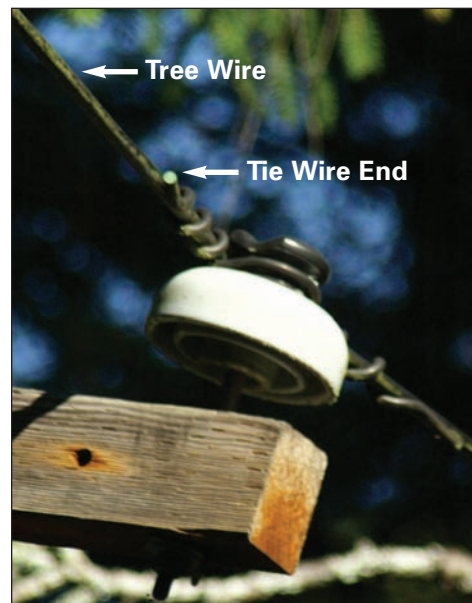

Figure 3-56
Tree Wire Tie Wire

Idle Split Bolt Connectors



Figure 3-57
Idle Split Bolt Connectors

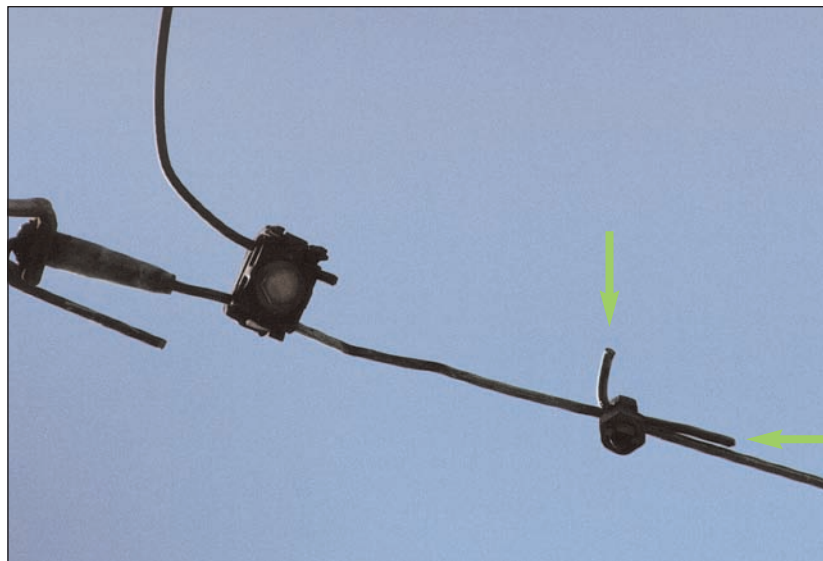

Figure 3-58
**Close Up of Non-exempt Split Bolt
and Copper Parallel Groove Connector**

**Note: Split bolts are ONLY exempt when idle on the line.
See page 2-15 for non-exempt split bolts.**

Bolted Wedge Connectors

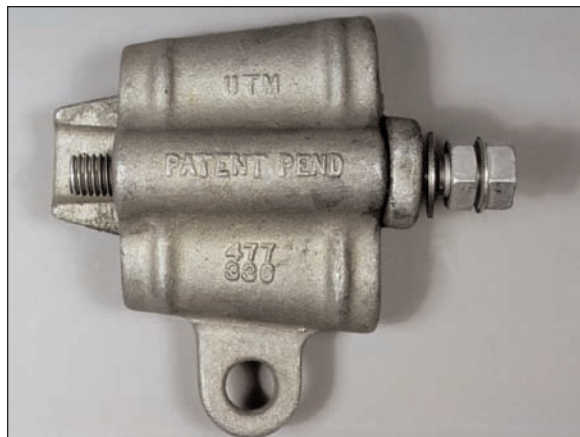

Figure 3-59
Bolted Wedge Connector

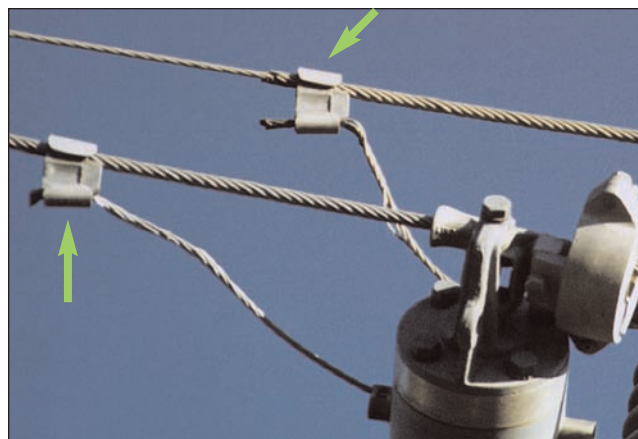

Figure 3-60
Fired Wedge Connectors on Line



Figure 3-61
Fired Wedge Connectors

Compression Connectors



Figure 3-62
**H-Type Compression Connector
(not compresses)**



Figure 3-63
**Copper Compression
Connector, (compressed)**

Figure 3-64
**H-Type Compression Connector
(compresses)**

Bolted Flat Plate Connector

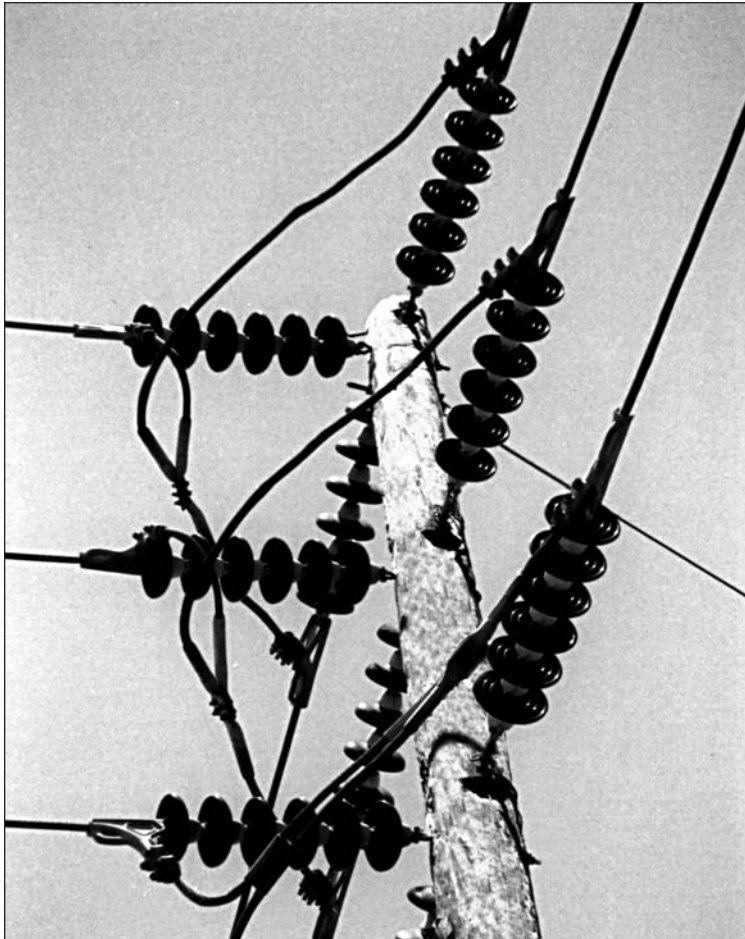

Figure 3-65
**Transmission Vertical Deadend
with Bolted Flat Plate Connector**



Figure 3-66
Bolted Flat Plate Connector

Automatic Deadend

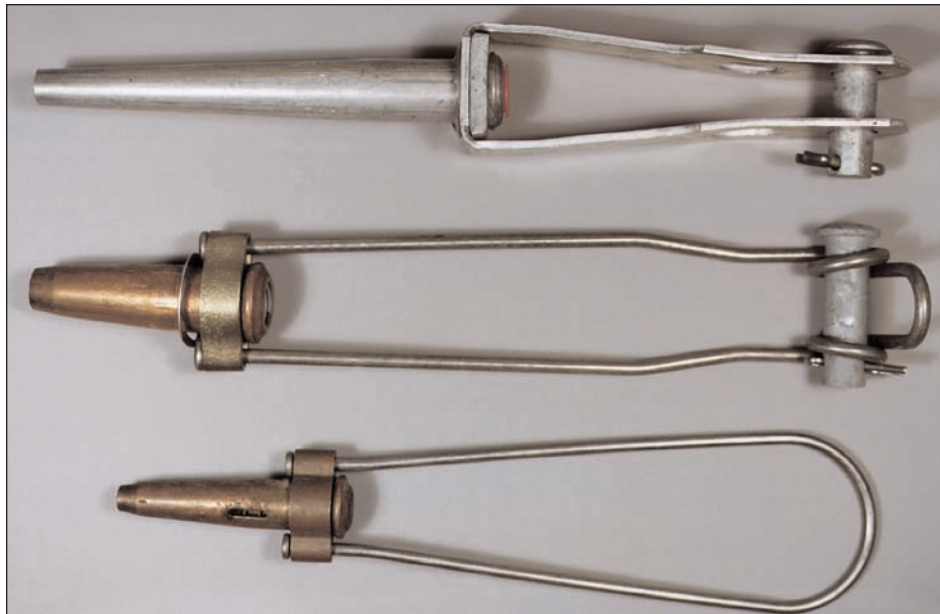

Figure 3-67
Automatic Deadends



Figure 3-68
**Automatic Deadends with
Suspension Insulators**



Figure 3-69
**Automatic Deadends Attached to
Pole and Crossarm**

Splices



Figure 3-70
Line Splices



Figure 3-71
Compressed Line Splice

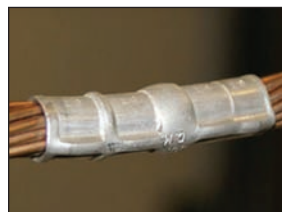

Figure 3-72
Compressed Line Splice



Figure 3-73
Automatic Line Splices

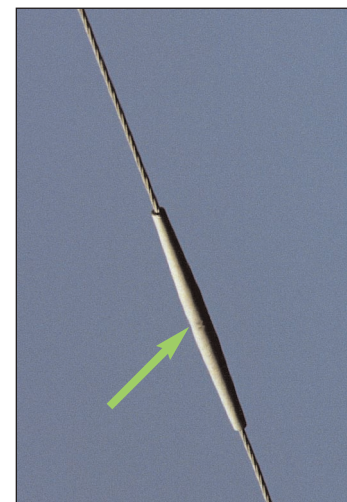

Figure 3-74
Automatic Line Splice
Installed on Line

Section 4 Construction

Distribution Construction



Figure 4-1
Vertical Angle



Figure 4-2
Triangular

Distribution Construction

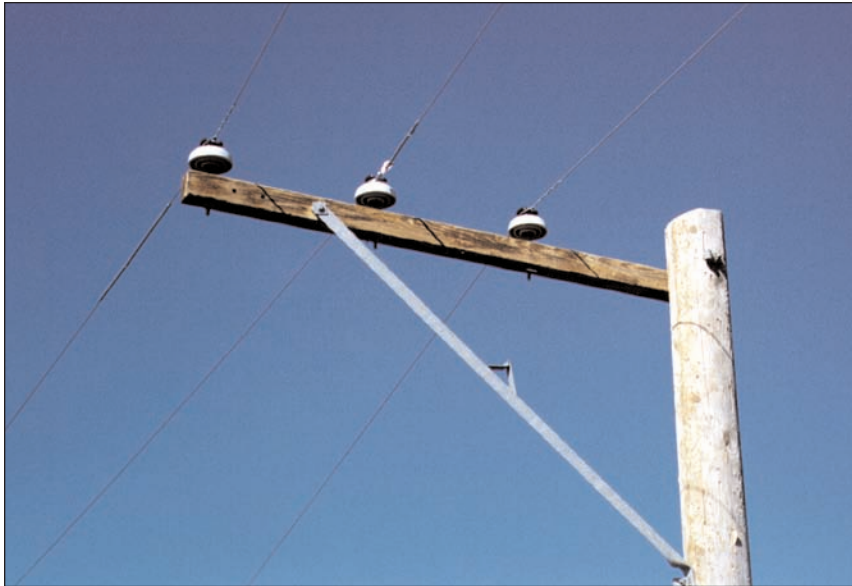

Figure 4-3
Alley Arm



Figure 4-4
Crossarm (Tangent)

Distribution Construction



Figure 4-5
Tangent Crossarm with Deadend Tap (T-Tap)



Figure 4-6
Crossarm Deadend Corner (Line and Buck)

Distribution Construction

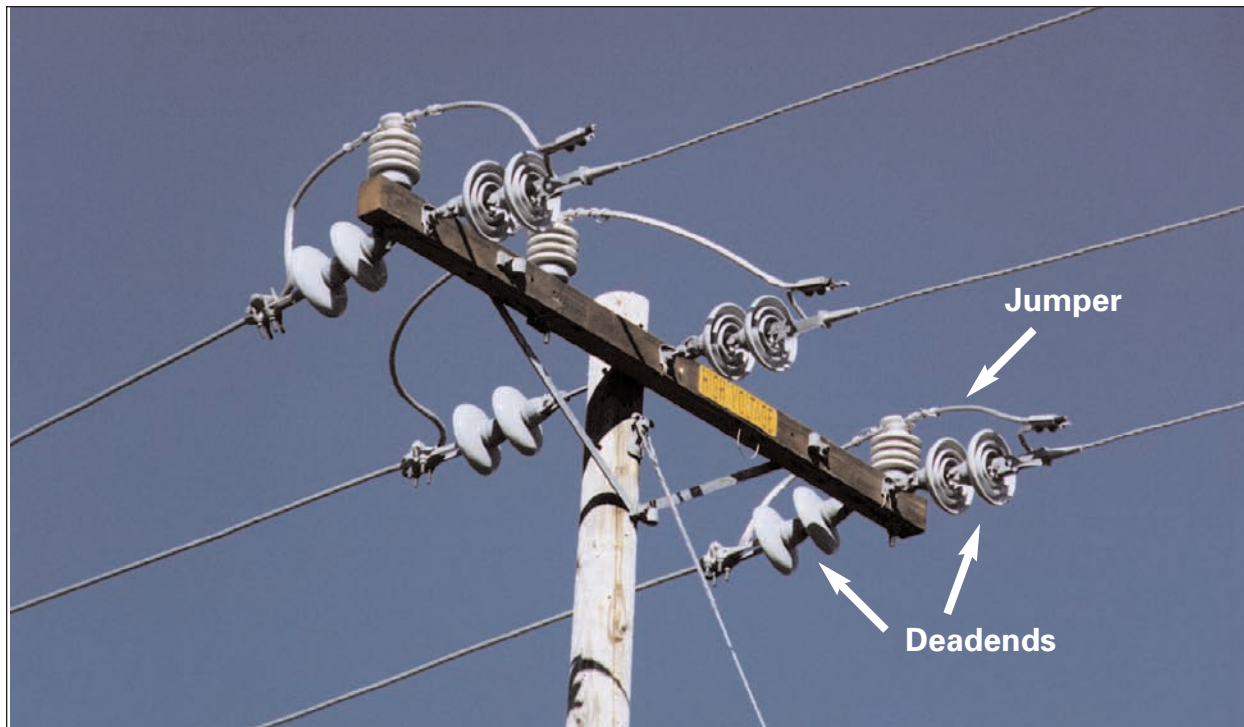

Figure 4-7
Crossarm Double Deadend

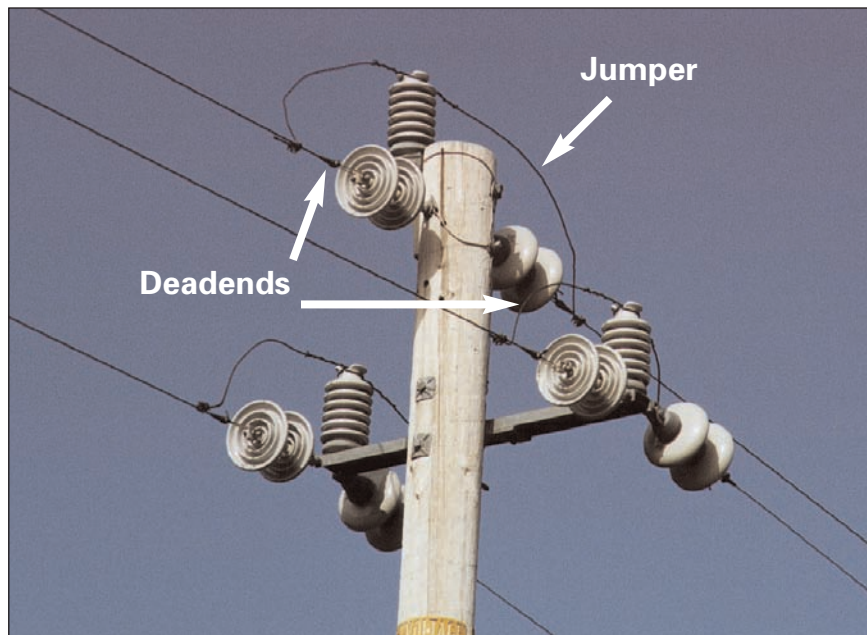

Figure 4-8
Triangular Double Deadend

Distribution Construction

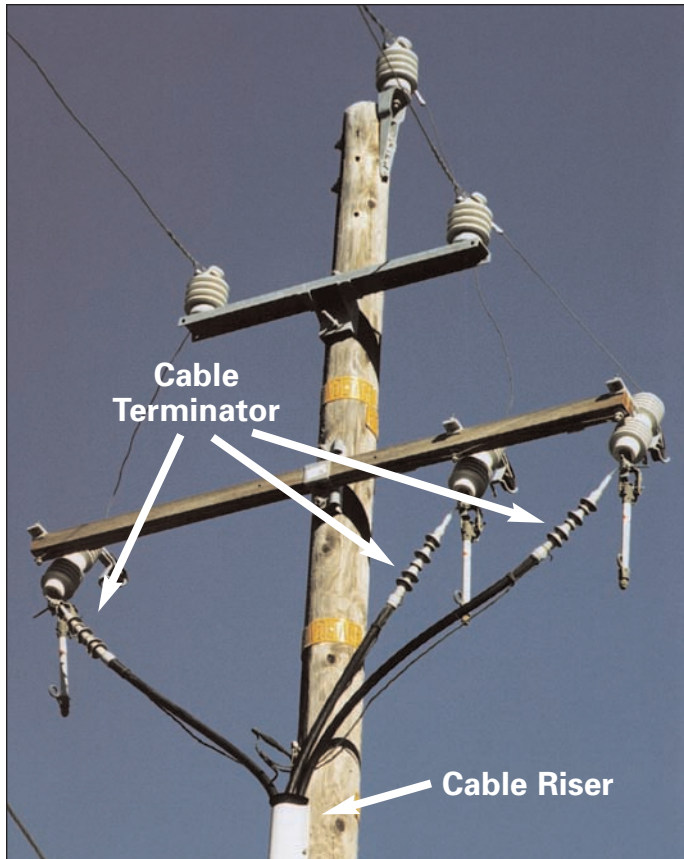

Figure 4-9
Cable Riser with Cable Terminator

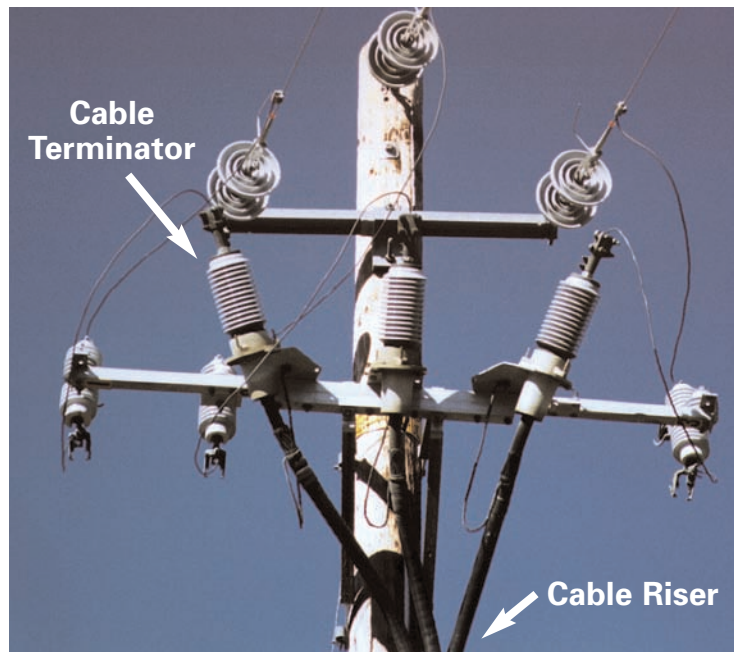

Figure 4-10
Cable Riser with Cable Terminator

Distribution Construction

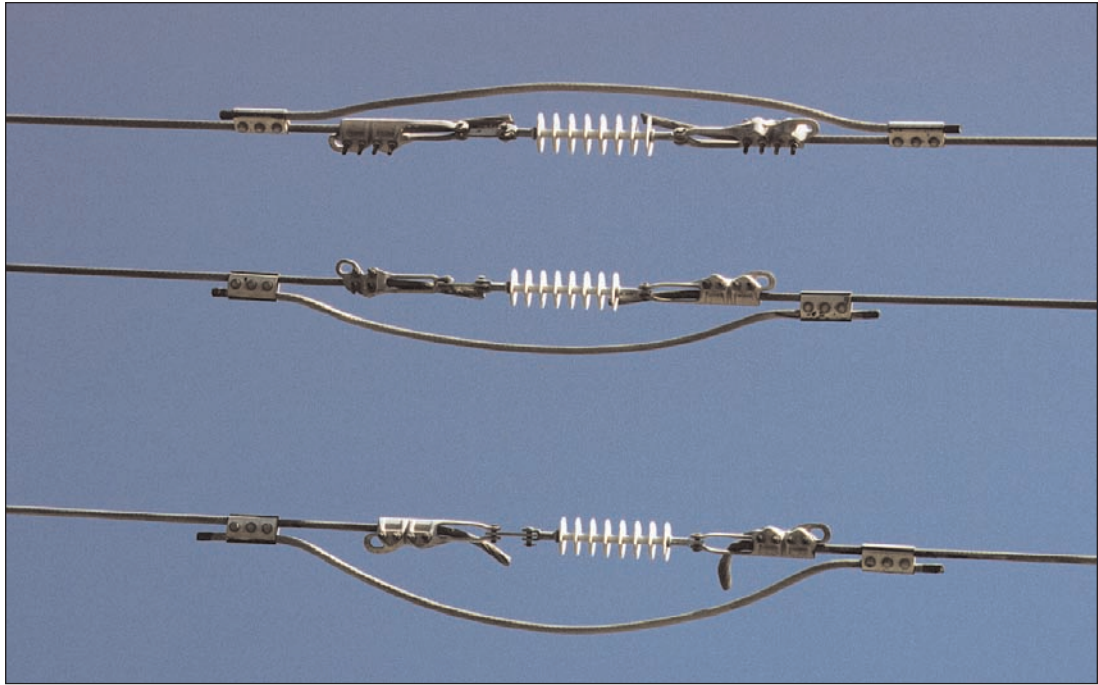

Figure 4-11
Line Opener



Figure 4-12
Long Span Conductor Spreader

Distribution Construction



Figure 4-13
Vibration Damper

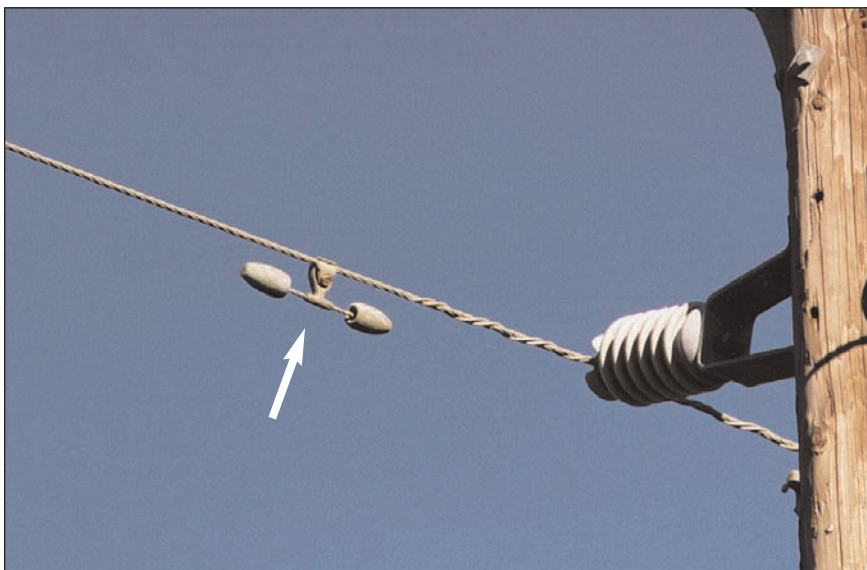

Figure 4-14
Vibration Damper

Animal and Raptor Protection

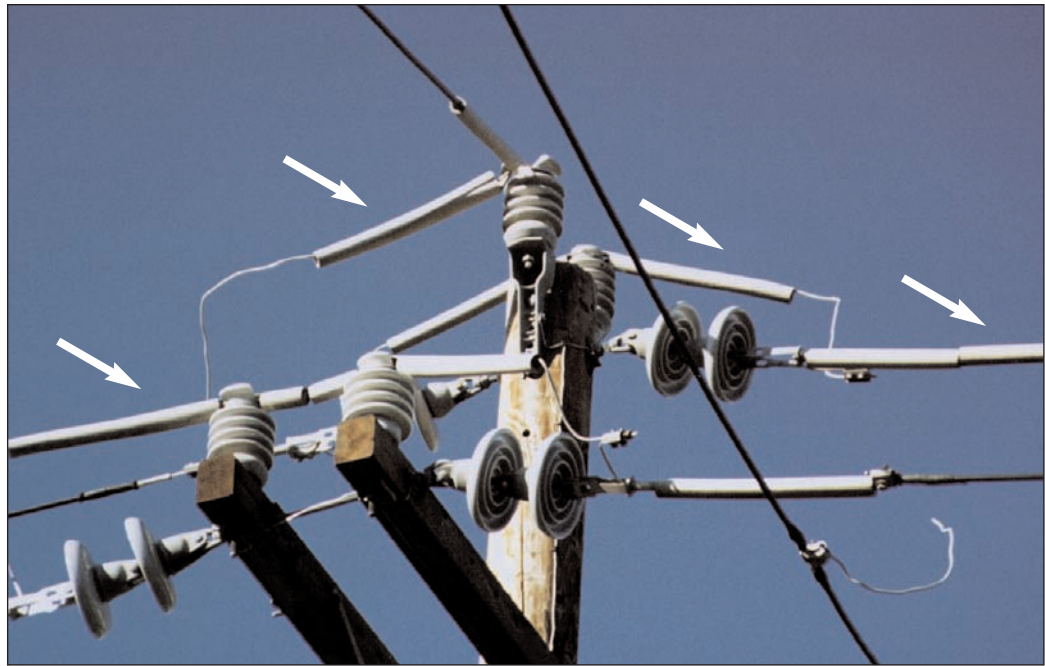

Figure 4-15
Insulated Conductor Covering



Figure 4-16
Raptor Perch

Animal and Raptor Protection

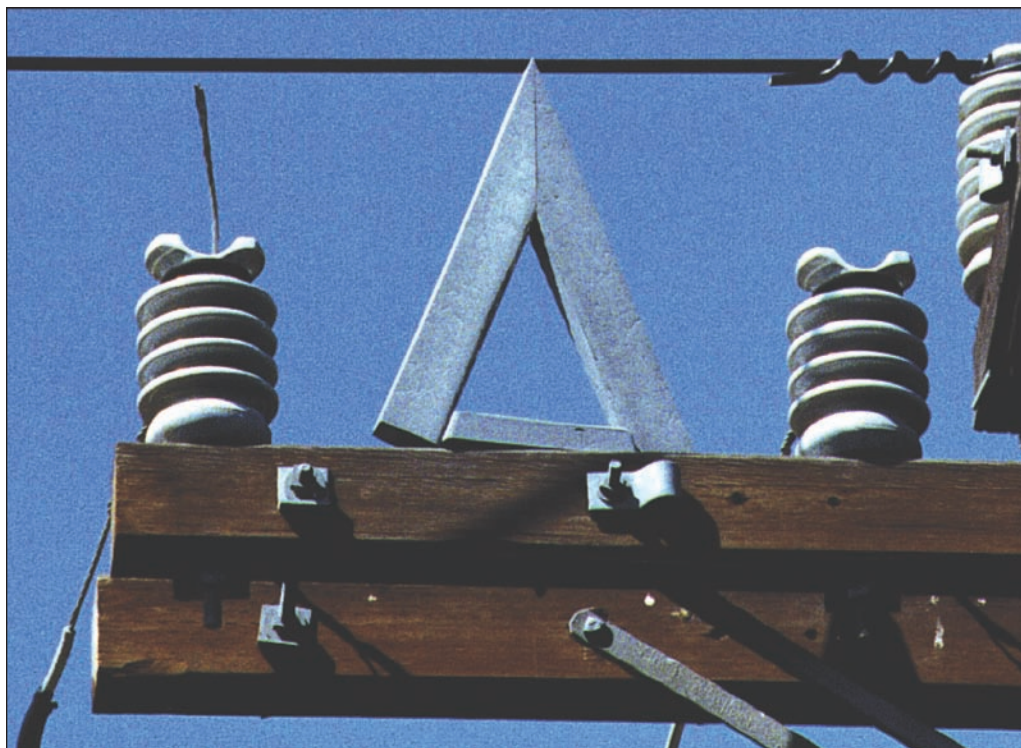

Figure 4-17
Anti-Perch Guard



Figure 4-18
Anti-Perch Owl



Figure 4-19
Close up of Owl on Crossarm

Animal and Raptor Protection

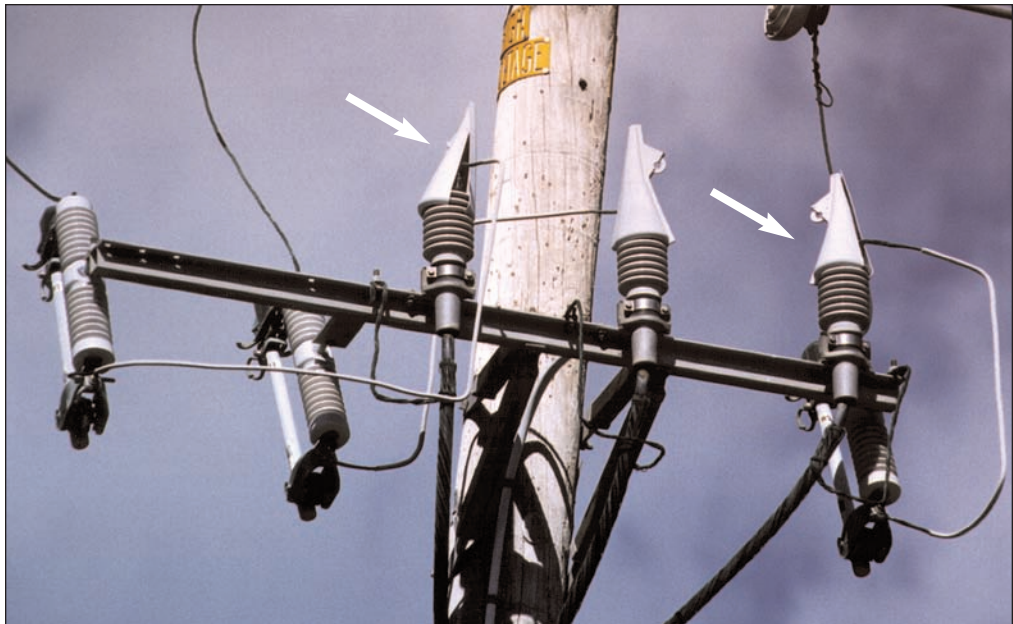

Figure 4-20
Squirrel Guard

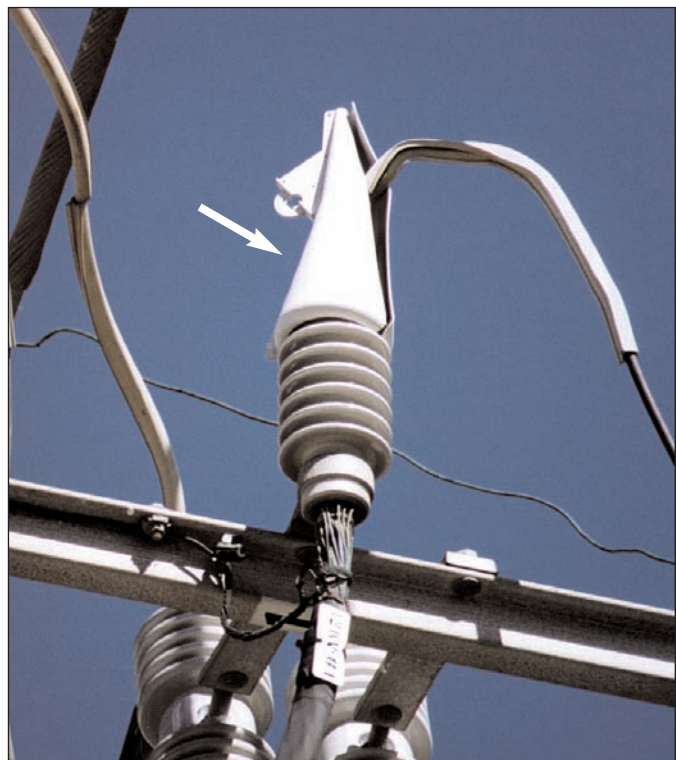

Figure 4-21
Close up of Squirrel Guard

Animal and Raptor Protection

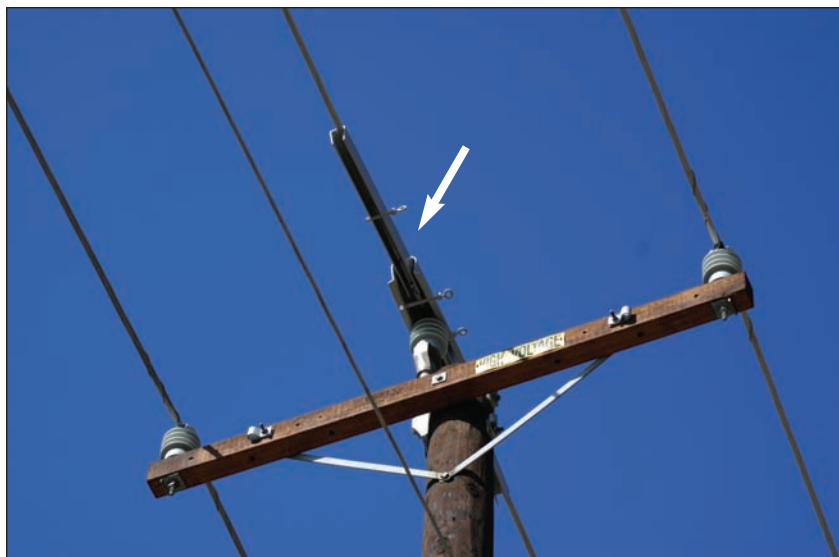

Figure 4-22
Raptor Protector Insulator and Wire Cover



Figure 4-23
Close up of Insulator and Wire Cover



Figure 4-24
Bushing Covers

Transmission Construction



Figure 4-25
Figure Four (4)

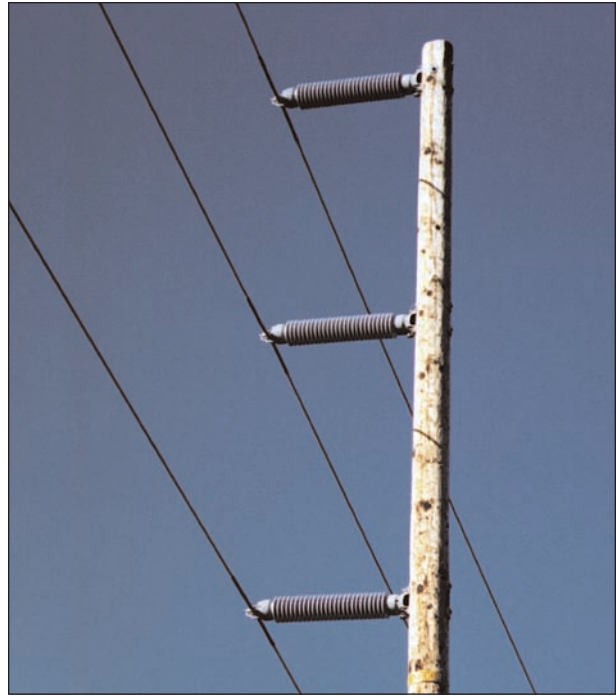

Figure 4-26
Vertical Post

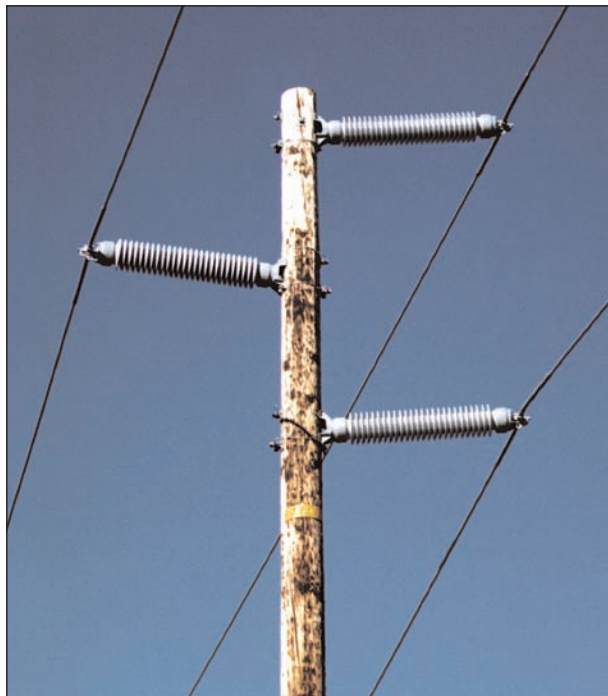

Figure 4-27
Triangular Post

Transmission Construction

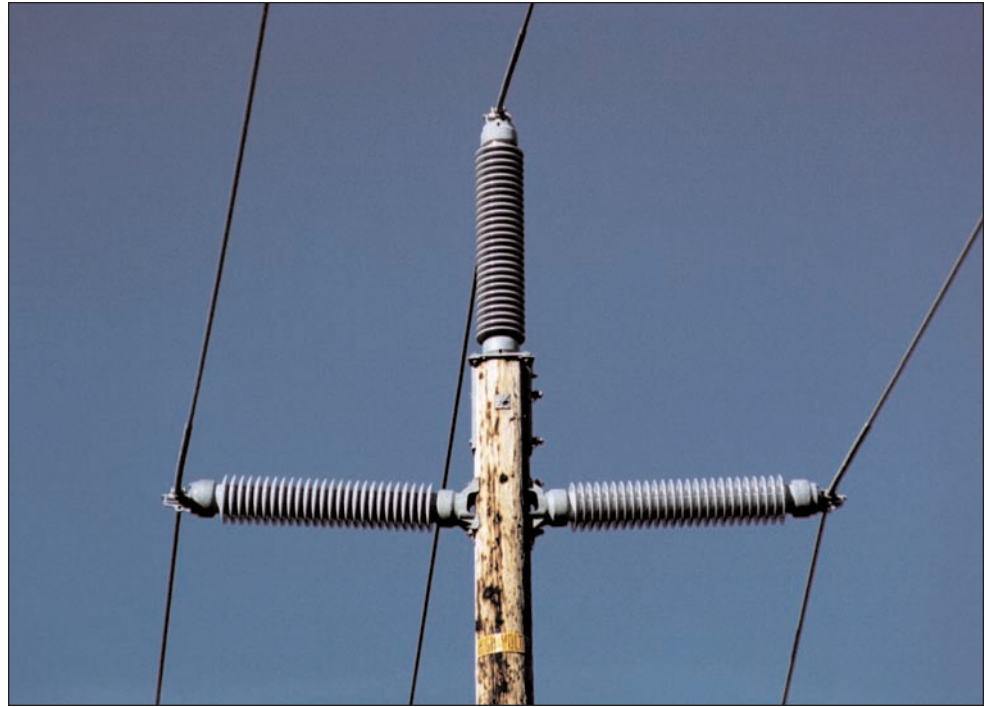

Figure 4-28
Triangular Configuration



Figure 4-29
Gull Wing

Transmission Construction

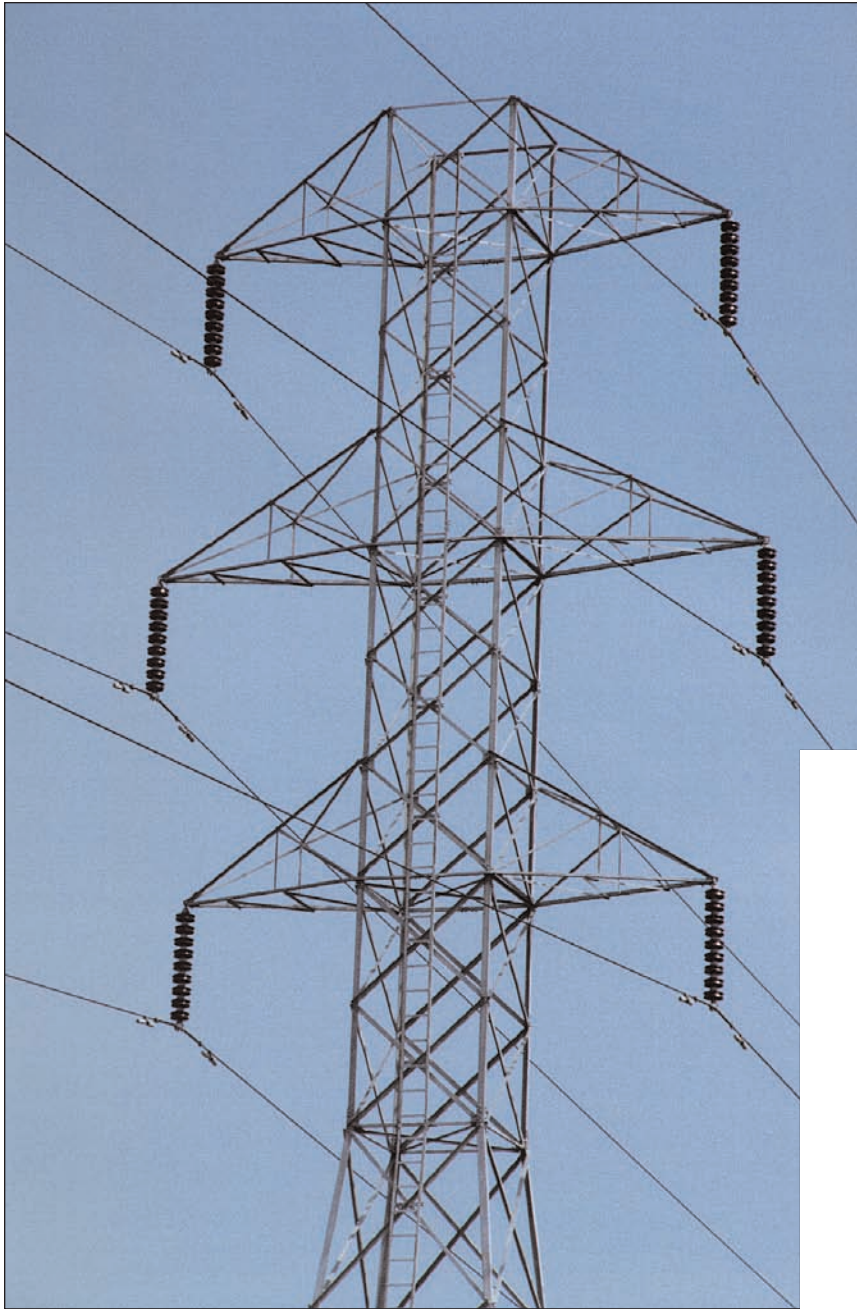

Figure 4-30
Suspension Tower

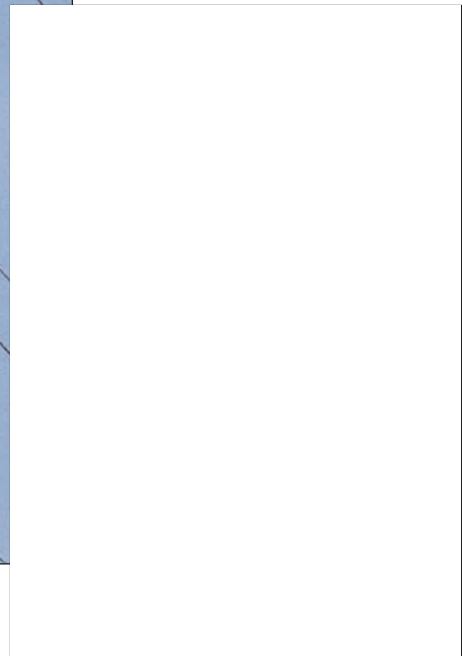

Figure 4-31
Close up of Suspension Insulators

Transmission Construction



Figure 4-32
Deadend Tower

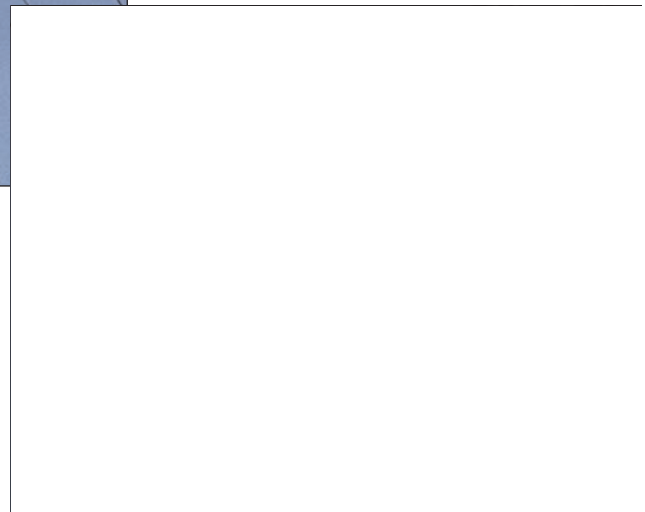

Figure 4-33
Close up of Deadend Insulators

Transmission Construction

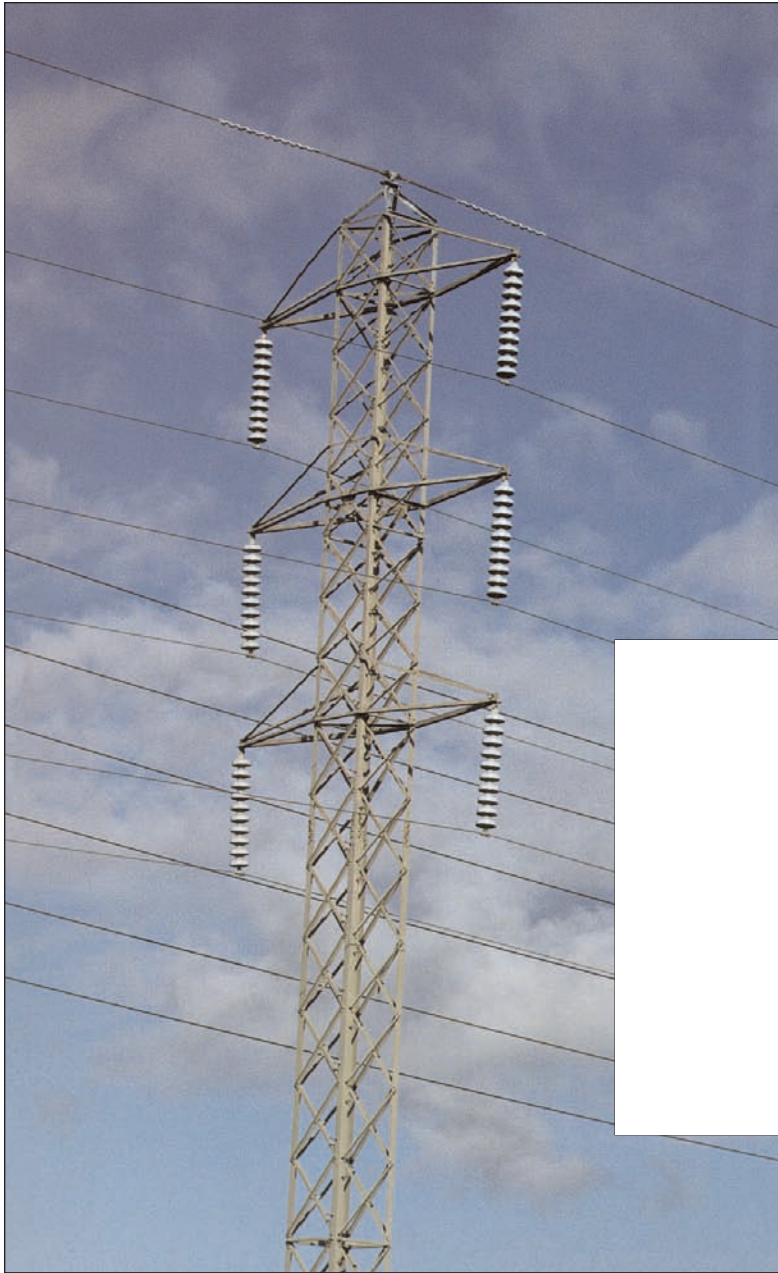

Figure 4-34
Tangent Transmission Tower with Static Line

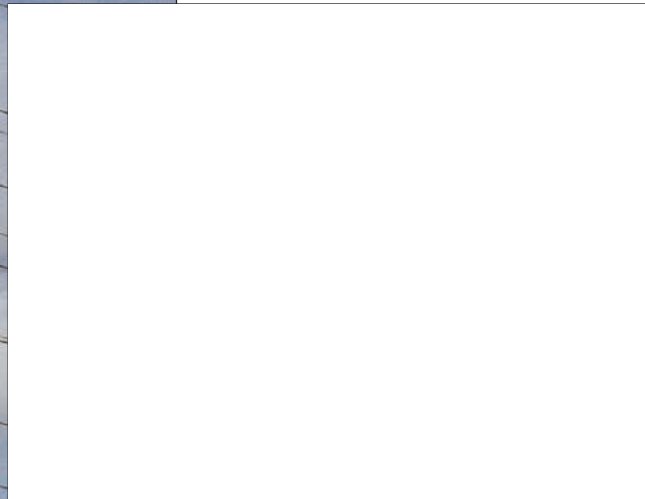

Figure 4-35
Close up of Static Line

Section 5

Bulletins/Correspondence

Section 6

List of Figures/Glossary of Terms

List of Photographs and Figures

Section 1: Introduction

Figure 1-1: Electrical Power System	1-3
Figure 1-2: Major California Utility Companies	1-4
Figure 1-3: California Interagency Fire Safety Inspection Legal Notice (FS 5100-209 and CDF LE-38)	1-15
Figure 1-4: California Interagency Fire Safety Inspection Legal Notice (CDF LE-38A).....	1-16
Figure 1-5 (front): Notice of Defensible Space Inspection Instructions.....	1-17
Figure 1-5 (back): Notice of Defensible Space Inspection	1-18
Figure 1-7: Notice of Defensible Space Inspection	1-18
Figure 1-6: Non-Exempt Pole Identification – Southern California Edison	1-19
Figure 1-7: Non-Exempt Pole Identification – Pacific Gas & Electric	1-19
Figure 1-8: Definition of Outer Circumference Examples.....	1-40
Figure 1-9: Time of Year by Location when Powerline Hazard Reduction Standards are Applicable	1-41
Figure 1-10: Fire Break Clearance Requirements Around Poles and Towers	1-42
Figure 1-11: Conductor Clearance	1-43
Figure 1-12: Burning Permits; Zones; Times	1-44

Section 2: Non-Exempt Equipment

Figure 2-1: Universal Fuse.....	2-1
Figure 2-2: Universal Fuse – Detail	2-1
Figure 2-3: Arm Mounted Cutout with Universal Fuse	2-1
Figure 2-4: Arm Mounted Cutout with Open Link Fuse.....	2-2
Figure 2-5: Open Link Fuse	2-2
Figure 2-6: Bushing Mounted Cutout with Open Link Fuse	2-3
Figure 2-7: Close up of Open Link Fuse	2-3
Figure 2-8: Enclosed Cutouts	2-4
Figure 2-9: Open 4KV Cutout.....	2-4
Figure 2-10: Arm Mounted Enclosed Cutout with Universal Fuses	2-4
Figure 2-11: Arm Mounted Cutout with Solid Blade Disconnect (closed)	2-5
Figure 2-12: Arm Mounted Cutout with Solid Blade Disconnect (open)	2-5
Figure 2-13: Solid Blade Disconnects.....	2-6
Figure 2-14: Solid Blade Disconnect	2-7
Figure 2-15: In-Line Disconnect (closed).....	2-8
Figure 2-16: In-Line Disconnects (closed)	2-8
Figure 2-17: In-Line Disconnect (open).....	2-9
Figure 2-18: In-Line Disconnects (open)	2-9
Figure 2-19: Arm Mounted Lightning Arrester (with Cable Riser and Universal Fuses).....	2-10
Figure 2-20: Lightning Arrester (with Recloser).....	2-10
Figure 2-21: Lightning Arrester	2-11
Figure 2-22: Lightning Arrester	2-11
Figure 2-23: Non-Porcelain Lighting Arrester.....	2-12
Figure 2-24: Non-Porcelain Lighting Arrester.....	2-12
Figure 2-25: Transformer Mounted Lightning Arrester	2-13
Figure 2-26: Gapped Lightning Arrester.....	2-13
Figure 2-27: Lightning Arrester	2-14
Figure 2-28: Lightning Arrester	2-14
Figure 2-29: Hot Tap Clamps	2-15

Figure 2-30: Hot Tap Clamps2-15

Figure 2-31: Threads2-15

Figure 2-32: Split Bolt Connectors (various sizes).....2-16

Figure 2-33: Split Bolt Connector2-16

Figure 2-34: Split Bolt Connectors2-16

Figure 2-35: Fargo Connector2-17

Figure 2-36: Fargo Connector (close up)2-17

Figure 2-37: LM Connector2-17

Figure 2-38: Grasshopper Air Switch (closed).....2-18

Figure 2-39: Grasshopper Air Switch (open)2-18

Figure 2-40: Transmission Air Switch, Pole Mounted 60kV (closed)2-19

Figure 2-41: Transmission Air Switches Tower Mounted (closed)2-20

Figure 2-42: Transmission Air Switches Pole Mounted (closed)2-20

Figure 2-43: Transmission Air Switches Tower Mounted (open)2-20

Section 3: Exempt Equipment

Figure 3-1: Arm Mounted Cutout with Non-Expulsion Fuse3-1

Figure 3-2: Arm Mounted Cutout with Non-Expulsion Fuse3-1

Figure 3-3: Arm Mounted Cutout with Non-Expulsion Fuses3-1

Figure 3-4: Bushing Mounted Cutout with Non-Expulsion Fuse3-2

Figure 3-5: Bushing Mounted Cutout with Non-Expulsion Fuse3-2

Figure 3-6: Energy Limiting Fuse with Open Link Cutout3-3

Figure 3-7: Energy Limiting Fuse with Clip Style Cutout3-3

Figure 3-8: Energy Limiting Fuse3-3

Figure 3-9: Energy Limiting Fuse Fault Indicator Cap.....3-3

Figure 3-10: Arm Mounted Cutout with Liquid Filled Fuse3-4

Figure 3-11: Liquid Filled Fuse3-4

Figure 3-12: Bushing Mounted Cutout with Liquid Filled Fuse3-5

Figure 3-13: Liquid Filled Fuse3-5

Figure 3-14: Arm Mounted Cutout with SMU-20 Fuses3-6

Figure 3-15: SMU-20 Fuse - Detail3-6

Figure 3-16: Arm Mounted Cutout with SMU-20 Fuses3-6

Figure 3-17: Arm Mounted Cutout with S&C Fault Tamer Fuse.....3-7

Figure 3-18: S&C Fault Tamer Fuse (closed)3-7

Figure 3-19: S&C Fault Tamer Fuse (open)3-7

Figure 3-20: 600 Amp KPF Air Switch, Triangular Construction (closed)3-8

Figure 3-21: 600 Amp KPF Air Switch, Triangular Construction (open)3-8

Figure 3-22: 600 Amp KPF Air Switch, Crossarm Construction (closed)
with arcing horns & snuffers.....3-9

Figure 3-23: 600 Amp KPF Air Switch, Crossarm Construction (closed)
without arcing horns or snuffers.....3-9

Figure 3-24: 600 Amp Underarm Sidebreak Switch (open)3-10

Figure 3-25: Open Unit3-10

Figure 3-26: Closed Unit3-10

Figure 3-27: 600 Amp Underarm Sidebreak Switch (closed)3-10

Figure 3-28: S&C 600 Amp Underarm Sidebreak Switch (open)3-11

Figure 3-29: S&C 600 Amp Underarm Sidebreak Switch (closed)3-11

Figure 3-30: S&C Omni-Ruptor Switch, Triangular Construction (open).....3-12

Figure 3-31: S&C Omni-Ruptor Switch, Tangent Construction (closed)3-12

Figure 3-32: Closed Unit3-12

Figure 3-33: S&C Scada-Mate Switch3-13

Figure 3-34 Open Position3-13

Figure 3-35: Closed Position3-13

Figure 3-36: Recloser with In-Line Disconnects (open)3-14

Figure 3-37: Recloser with Solid Blade Disconnects (closed)3-14

Figure 3-38: Sectionalizer with Solid Blade Disconnects3-15

Figure 3-39: Sectionalizer3-15

Figure 3-40: Voltage Regulator with Solid Blade Disconnects3-16

Figure 3-41: Voltage Regulator3-16

Figure 3-42: Capacitor Bank3-17

Figure 3-43: Capacitor Unit3-17

Figure 3-44: Self-Protected Transformer3-18

Figure 3-45: Conventional Transformer with Exempt Fuses.....3-18

Figure 3-46: Parallel Groove Connectors3-19

Figure 3-47: Parallel Groove Connectors - Copper3-19

Figure 3-48: Parallel Groove Conectors on Jumpers3-19

Figure 3-49: Transmission Deadend with Parallel Groove Connectors3-20

Figure 3-50: Hot Tap Clamps3-21

Figure 3-51: Hot Tap Clamps Ears3-21

Figure 3-52 Hot Tap Clamps on Line3-21

Figure 3-53: Piercing Hot Tap Clamp on Tree Wire3-22

Figure 3-54: Piercing Hot Tap Clamp - Detail3-22

Figure 3-55: Tree Wire - Detail3-23

Figure 3-56: Tree Wire Tie Wire3-23

Figure 3-57: Idle Split Bolt Connectors3-24

Figure 3-58: Close up of Non-exempt Split Bolt and Copper Parallel Groove Connector.....3-24

Figure 3-59: Bolted Wedge Connector3-25

Figure 3-60: Fired Wedge Connector on Line3-25

Figure 3-61: Fired Wedge Connectors3-25

Figure 3-62: H-Type Compression Connectors (not compressed)3-26

Figure 3-63 Copper Compression Connector (compressed).....3-26

Figure 3-64: H-Type Compression Connector (compressed)3-26

Figure 3-65: Transmission Vertical Deadend with Bolted Flat Plate Connector3-27

Figure 3-66: Bolted Flat Plate Connector3-27

Figure 3-67: Automatic Deadends.....3-28

Figure 3-68: Automatic Deadends with Suspension Insulators3-28

Figure 3-69: Automatic Deadends Attached to Pole and Crossarm3-28

Figure 3-70: Line Splices3-29

Figure 3-71: Compressed Line Splice3-29

Figure 3-72 Compressed Line Splice3-29

Figure 3-73: Automatic Line Splices3-29

Figure 3-74: Automatic Line Splice3-29

Section 4: Construction

Figure 4-1: Vertical Angle4-1

Figure 4-2: Triangular4-1

Figure 4-3: Alley Arm4-2

Figure 4-4: Crossarm (Tangent)4-2

Figure 4-5: Tangent Crossarm with Deadend Tap (T-Tap).....4-3

Figure 4-6: Crossarm Deadend Corner (Line and Buck)4-3

Figure 4-7: Crossarm Double Deadend4-4
Figure 4-8: Triangular Double Deadend4-4
Figure 4-9: Cable Riser with Cable Terminator4-5
Figure 4-10: Cable Riser with Cable Terminator4-5
Figure 4-11: Line Opener4-6
Figure 4-12: Long Span Conductor Spreader.....4-6
Figure 4-13: Vibration Damper4-7
Figure 4-14: Vibration Damper4-7
Figure 4-15: Insulated Conductor Covering.....4-8
Figure 4-16: Raptor Perch4-8
Figure 4-17: Anti-Perch Guard4-9
Figure 4-18: Anti-Perch Owl4-9
Figure 4-19: Close up of Owl on Crossarm.....4-9
Figure 4-20: Squirrel Guard.....4-10
Figure 4-21: Close up of Squirrel Guard4-10
Figure 4-22: Raptor Protector with Wire Cover4-11
Figure 4-23: Close up of Insulator and Wire Cover4-11
Figure 4-24: Bushing Cover.....4-11
Figure 4-25: Figure Four (4)4-12
Figure 4-26: Vertical Post.....4-12
Figure 4-27: Triangular Post4-12
Figure 4-28: Triangular Configuration4-13
Figure 4-29: Gull Wing4-13
Figure 4-30: Suspension Tower.....4-14
Figure 4-31: Close up of Suspension Tower4-14
Figure 4-32: Deadend Tower4-15
Figure 4-33: Close up of Deadend Insulators4-15
Figure 4-34: Tangent Transmission Tower with Static Line4-16
Figure 4-35: Close up of Static Line4-16

Glossary of Terms

- Ampere** - Unit of electric current (One volt applied across one ohm of resistance will produce one ampere of current).
- Armor Rods** - Metal rods wrapped around conductors and attached to insulators that prevent wear and fatigue of the conductors.
- Automatic Recloser** - Pole mounted, oil-filled switch that will open a circuit automatically if faulted and then may close automatically to try to complete the circuit again.
- Capacitor Bank** - Pole mounted device for neutralizing inductive load to correct the power factor.
- Circuit-Transmission** - High voltage circuit (50-500 kV) between generating source and switchyard (substation).
- Circuit-Distribution** - Circuit between main switchyard and point of use.
- Circuit-Primary Distribution** - High voltage circuit (2.4-35 kV) between switchyard and service transformer.
- Circuit-Secondary Distribution** - Low voltage (750 volt, usually 120, 208, 240, or 480) circuit between transformer and point of use.
- Clearance** - Space cleared of vegetation as required by law, regulation, easement, etc., for the purpose of preventing power line-caused fires.
- Clearance-Conductor** - Distance from overhead open conductors which must be kept free of vegetation; distance varies depending on voltage carried by conductors.
- Clearance-Pole** - Radial space around base of pole or tower, measured horizontally, which must be kept free of flammable vegetation if certain hardware is in use overhead.
- Conductor** - Path through which an electric current flows, metal wire or cable.
- Conductor** - Unprotected - Uninsulated conductor.
- Connector** - Mechanical device used to join two conductors.
- Connector-Automatic** - Sleeve type connector requiring tension on the conductors to maintain connection; unsafe in non-tension situation.
- Connector-Bolted** - A device used for fastening two or more conductors together.
- Connector-Compression** - A device for joining two conductors together when a metal sleeve is used and mechanically or hydraulically pressed to secure tension (no bolts). For purpose of the PRC, a compression connector is considered to make the conductor continuous.
- Connector-Fired Wedge** - A connector joining the conductors by compressing them between two wedge-shaped objects. Exempt from clearance requirements.
- Connector-Parallel Groove** - A connector so designed that tightening of one or more bolts will compress sides of connector against conductors placed in performed grooves. Exempt from clearance requirements.
- Connector-Plate** - A connector joining the conductors by bolting two flat plates together. If two or more bolts are used, this type of connector is exempt from clearance requirements.
- Corner Pole** - Any pole (tower) where the conductors make an angle of 60 degrees or more from their previous alignment.
- Current** - Flow of electricity measured in amperes.
- Current Limiting Fuse** - A device used in conjunction with fuses near where heavy fault currents will occur.
- Dead End** - Point where the conductors end; other conductors in many cases will continue on and be connected to the preceding conductors by jumper wires and various forms of connectors.
- Disconnect** - See Pole Disconnect.
- De-Energized** - Dead, disconnected from electrical energy.
- Energized** - Live, connected to a source of electrical energy.

- Exempt** - Does not require clearance of flammable vegetation.
- Fault** - A break in the circuit, an unwanted path for electric current.
- Fire Hazard** - Dangerous accumulation of flammable fuels in wildland areas usually referring to vegetation.
- Fuse-Cutout** - A device designed to open the circuit in case of short or overload.
- Fuse-Open Link (Trip-O-Link)** - A non-exempt, low current (050 Amp) fuse.
- Fuse-Universal** - A non-exempt, medium capacity (50-100 Amp) fuse.
- Fuse-Liquid Filled** - An exempt type of fuse in which the fusible link is entirely enclosed in liquid.
- Ground** - To connect a line or piece of equipment to the earth.
- Hot Clamp** - A type of bolted connector which can be installed without de-energizing the circuit.
- Insulation** - Protective covering, around a conductor or other piece of equipment, which is a non-conductor of electricity (not just a weather resistant cover).
- Insulator** - Porcelain or non-ceramic unit used to support and separate conductors from each other and from ground (Air can also be an insulator).
- Kilovolt** - 1,000 volts (kV).
- Lightning Arrester** - A device designed to channel lightning or over voltage it to ground in order to protect the circuit or equipment from excessive fault current.
- Non-Exempt** - Requires clearance of flammable vegetation.
- Ohm** - Unit of resistance to flow of electric current (One ohm of resistance requires one volt of energy to push one ampere of current across it).
- Phase** - One wire or conductor of a circuit.
- Pole Disconnect** - Type of switch mounted on a pole (Blades are opened and closed manually one at a time). Same as disconnect.
- Pole Switch** - Switch mounted on a pole (All blades open and close together with one handle).
- Regulator-Voltage** - Pole-mounted device for correcting voltage.
- Risk-Fire** - Potential for ignition of fuels or an ignition agent.
- Self-Supporting Aerial Cable** - Several insulated conductors wrapped around a non-energized steel support cable, used primarily for service drops and secondary conductor.
- Service Drop** - Portion of the power line from the secondary distribution line to the point-of-use (between pole and house).
- Split-bolt Connectors-Kearney** - A type of bolted connector.
- Switchyard-Substation** - An area in which are located switches, transformers, circuit breakers, etc., and where voltages are changed to or from transmission levels.
- Transformer** - A device, mounted on a pole, pad, vault, or in a switchyard, encased in metal and used to reduce or increase voltage.
- Transformer Conventional** - A transformer with no internal fuses. Fuses are required between the transformer and the line.
- Transformer-CP Self-Protected** - Self-protected has internal fuses on the primary side and circuit breakers on the secondary side.
- Transformer-CSP** - Current surge protected same as CP but with externally mounted lightning arresters.
- Tree Wire** - Fully covered conductor .
- Vibration Dampers** - Hardware attached to conductors (usually near insulators) to inhibit fatigue from wind-caused vibration).
- Volt** - Unit of electric energy force (One volt is required to push one ampere of current across one ohm of resistance). Roughly analogous to psi of pressure in a fire hose.